

# Refractometers

RM40 / RM50

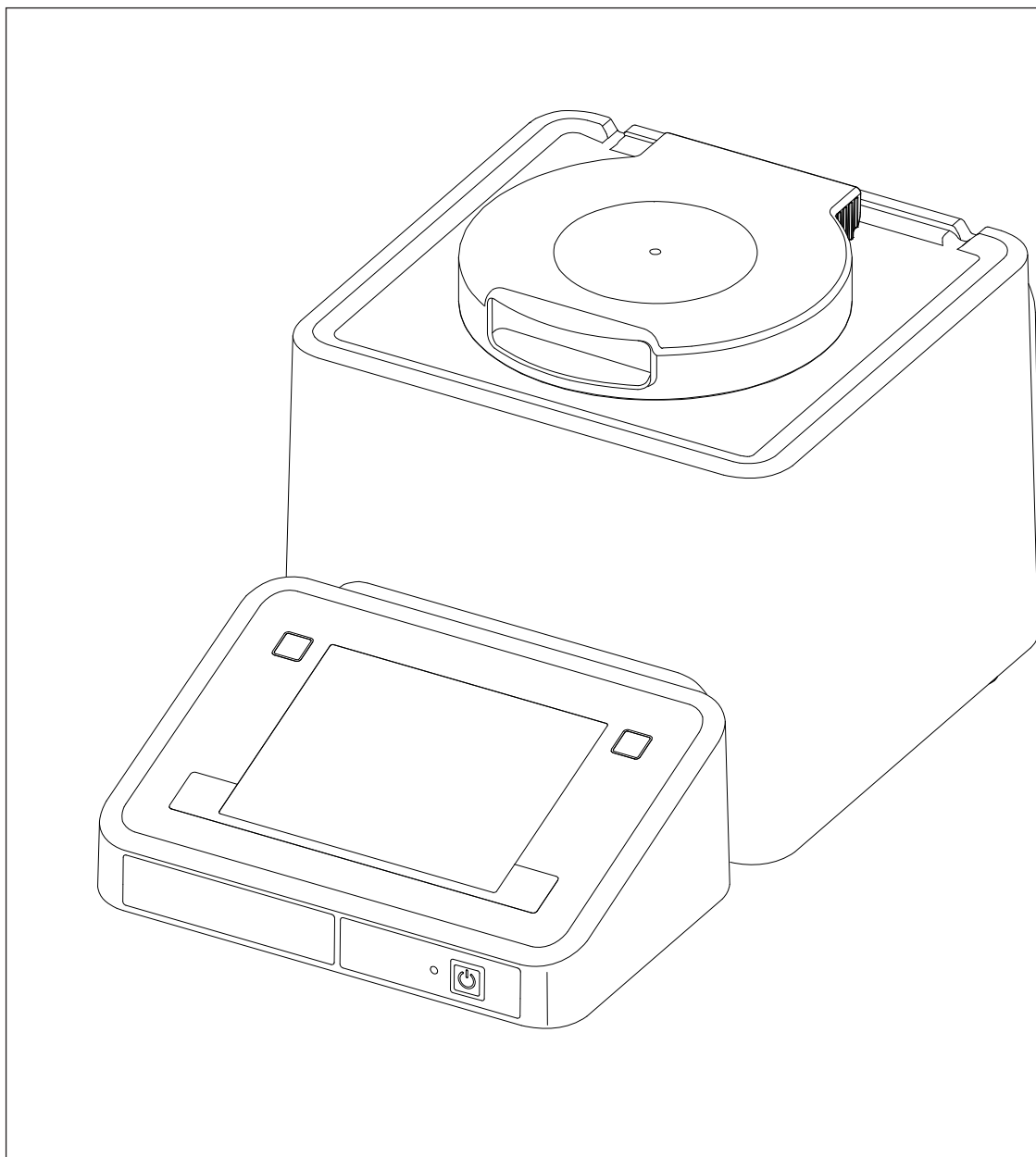

**METTLER TOLEDO**



# Table of Contents

|          |  |           |
|----------|--|-----------|
| <b>1</b> | <b>Introduction</b>                        | <b>7</b>  |
| <b>2</b> | <b>Description of the Refractometer</b>    | <b>8</b>  |
| <b>3</b> | <b>Principles of Refractometry</b>         | <b>10</b> |
|          | 3.1 Definition of the Refractive Index     | 10        |
|          | 3.2 Method of Measurement                  | 10        |
|          | 3.3 Design of Measuring Cell               | 10        |
| <b>4</b> | <b>Description of Functions</b>            | <b>12</b> |
|          | 4.1 Layout of the Terminal                 | 12        |
|          | 4.2 Operating the Touchscreen              | 12        |
|          | 4.3 Homescreen                             | 12        |
|          | 4.4 The User Interface                     | 13        |
|          | 4.4.1 Entering Data in the User Interface. | 13        |
|          | 4.4.2 Shortcuts                            | 14        |
| <b>5</b> | <b>Setup</b>                               | <b>15</b> |
|          | 5.1 Adjustments & Tests                    | 15        |
|          | 5.1.1 Adjustment Sets                      | 16        |
|          | 5.1.2 Test Sets                            | 16        |
|          | 5.2 Hardware                               | 16        |
|          | 5.2.1 Cell                                 | 17        |
|          | 5.2.2 Automation                           | 17        |
|          | 5.2.3 External Instruments                 | 19        |
|          | 5.2.4 Peripherals                          | 20        |
|          | 5.2.5 Sensors                              | 23        |
|          | 5.2.6 Auxiliary instruments                | 24        |
|          | 5.3 User settings                          | 25        |
|          | 5.3.1 Language                             | 25        |
|          | 5.3.2 Screen                               | 25        |
|          | 5.3.3 Beep                                 | 25        |
|          | 5.3.4 Shortcuts                            | 26        |
|          | 5.3.5 Keyboards                            | 26        |
|          | 5.4 Global Settings                        | 26        |
|          | 5.4.1 System                               | 26        |
|          | 5.4.2 User Management                      | 26        |
|          | 5.4.2.1 Users                              | 27        |
|          | 5.4.2.2 Account Policy                     | 27        |
|          | 5.4.2.3 User Groups                        | 27        |
|          | 5.4.3 Analysis and Resources Behavior      | 28        |
|          | 5.4.4 Physical Properties                  | 29        |
|          | 5.5 Tables & Values                        | 29        |
|          | 5.5.1 Tables                               | 30        |
|          | 5.5.2 Auxiliary Values                     | 31        |
|          | 5.6 Maintenance & Service                  | 31        |
|          | 5.6.1 MT Service                           | 31        |
|          | 5.6.2 Import / Export                      | 32        |
|          | 5.6.3 Add External Cell                    | 33        |
|          | 5.6.4 Reset to Factory Settings            | 33        |
|          | 5.6.5 Firmware                             | 33        |
|          | 5.6.6 Update                               | 33        |
|          | 5.6.7 Hardware / Firmware summary          | 34        |
|          | 5.6.8 Board Tests                          | 34        |

|          |                               |   |           |
|----------|-------------------------------|---|-----------|
|          | 5.6.9                         | Cell                                      | 34        |
|          | 5.6.10                        | Export Adjustments / Tests / Measurements | 35        |
| <b>6</b> | <b>Methods and Products</b>   |   | <b>36</b> |
|          | 6.1                           | Methods                                   | 36        |
|          | 6.1.1                         | Establishing Methods                      | 36        |
|          | 6.1.2                         | Creating a Method Copy                    | 38        |
|          | 6.1.3                         | Modifying or Deleting Methods             | 38        |
|          | 6.1.4                         | Method Syntax                             | 38        |
|          | 6.1.5                         | Standard Data                             | 40        |
|          | 6.1.6                         | Condition                                 | 40        |
|          | 6.1.7                         | Method Function                           | 41        |
|          | 6.1.7.1                       | Title                                     | 42        |
|          | 6.1.7.2                       | Configuration                             | 42        |
|          | 6.1.7.3                       | Sample                                    | 42        |
|          | 6.1.7.4                       | Fill                                      | 44        |
|          | 6.1.7.5                       | Measure                                   | 45        |
|          | 6.1.7.6                       | Calculation                               | 47        |
|          | 6.1.7.7                       | Clean                                     | 48        |
|          | 6.1.7.8                       | Online Display                            | 50        |
|          | 6.1.7.9                       | Report                                    | 50        |
|          | 6.1.7.10                      | Cell Test                                 | 51        |
|          | 6.1.7.11                      | Temperature Compensation                  | 51        |
|          | 6.1.7.12                      | Adjustment                                | 52        |
|          | 6.1.7.13                      | Test                                      | 52        |
|          | 6.1.7.14                      | Instruction                               | 52        |
|          | 6.1.7.15                      | Auxiliary Value                           | 52        |
|          | 6.1.7.16                      | Wait                                      | 53        |
|          | 6.1.7.17                      | Auxiliary instrument                      | 53        |
|          | 6.1.7.18                      | PowerShower                               | 54        |
|          | 6.1.7.19                      | Stir                                      | 55        |
|          | 6.1.7.20                      | Line rinse                                | 56        |
|          | 6.1.7.21                      | Park                                      | 56        |
|          | 6.2                           | Products                                  | 56        |
|          | 6.2.1                         | Create Products                           | 57        |
|          | 6.2.2                         | Linking Methods with Products             | 57        |
|          | 6.2.3                         | Parameters for Products                   | 57        |
|          | 6.2.4                         | Calculations in Products                  | 59        |
| <b>7</b> | <b>Series</b>                 |   | <b>60</b> |
|          | 7.1                           | Delete Series                             | 61        |
|          | 7.2                           | Creating a series copy                    | 61        |
| <b>8</b> | <b>Results and Statistics</b> |   | <b>62</b> |
|          | 8.1                           | Statistics                                | 63        |
|          | 8.2                           | Information                               | 63        |
|          | 8.3                           | Data                                      | 63        |
| <b>9</b> | <b>Manual Operation</b>       |   | <b>65</b> |
|          | 9.1                           | Automation                                | 65        |
|          | 9.1.1                         | Action: Dry                               | 65        |
|          | 9.1.2                         | Action: Rinse                             | 65        |
|          | 9.1.3                         | Action: Pump sample                       | 66        |
|          | 9.1.4                         | Action: Move to position                  | 66        |

|           |                                |   |           |
|-----------|--------------------------------|---|-----------|
|           | 9.2                            | Cell  | 66        |
|           | 9.2.1                          | Action: Cell conditioning                   | 67        |
|           | 9.2.2                          | Cell Test                                   | 67        |
| <b>10</b> | <b>Analysis Sequence</b>       |   | <b>68</b> |
|           | 10.1                           | Starting an Analysis                        | 68        |
|           | 10.2                           | Start from Editor (Methods/Products/Series) | 69        |
|           | 10.3                           | Start from Homescreen                       | 69        |
|           | 10.4                           | Start via Shortcuts                         | 69        |
|           | 10.5                           | Start with Barcode Reader                   | 69        |
|           | 10.5.1                         | Start with Handheld Reader                  | 70        |
|           | 10.5.2                         | Start with Built-in Barcode Reader          | 70        |
|           | 10.5.3                         | Start with ErgoSens                         | 70        |
|           | 10.6                           | Continuous run                              | 71        |
|           | 10.7                           | Analysis Termination                        | 71        |
|           | 10.8                           | Errors in the Analysis Sequences            | 71        |
|           | 10.8.1                         | Malfunction Types: Error                    | 71        |
|           | 10.8.2                         | Malfunction Types: Terminate error          | 71        |
|           | 10.8.3                         | Malfunction Types: Critical error           | 72        |
| <b>11</b> | <b>Tasks and Online Screen</b> |   | <b>73</b> |
|           | 11.1                           | Tasks                                       | 73        |
|           | 11.1.1                         | "Tasks" Button                              | 73        |
|           | 11.2                           | Online Screen                               | 73        |
|           | 11.2.1                         | Method type: Measurement                    | 73        |
|           | 11.2.2                         | Method Type: Adjustment                     | 74        |
|           | 11.2.3                         | Method Type: Test                           | 74        |
|           | 11.2.4                         | Method Type: Clean                          | 74        |
| <b>12</b> | <b>Appendix</b>                |   | <b>75</b> |
|           | 12.1                           | Raw Data                                    | 75        |
|           | 12.2                           | Result proposals                            | 76        |
|           | 12.3                           | Refractive Index for Water                  | 78        |
|           | 12.4                           | Density                                     | 78        |
|           | 12.5                           | Critical errors                             | 80        |
|           | <b>Index</b>                   |   | <b>82</b> |



# 1 Introduction

## **Simple and compact**

The METTLER TOLEDO RM40/RM50 refractometers are modern, compact instruments suitable for use in a vast diversity of application areas. They can be used, for example, in quality control as well as in research and development and meet the most demanding requirements.

These compact refractometers perfectly combine simple, easy-to-understand operation with an extremely high level of measuring accuracy and outstanding reliability. With their plug & play capability, they automatically detect external devices and sensors.

These refractometers can be operated as standalone instruments or run from a computer using the LabX PC software. Straightforward user guidance on the large color touchscreen enables intuitive operation. User-definable shortcuts allow all functions to be activated directly from the home screen with a single click.

Touchscreen control of the instrument and the method function parameters are described in the Operating Instructions. The Installation Instructions explain all the necessary steps for setting up your instrument. You are then guided through the first refractive index measuring process with the aid of a practical example.

If you have any additional questions, METTLER TOLEDO is always available to assist you.

## 2 Description of the Refractometer

The RM40 / RM50 refractometers measure the refractive index  $n_D$  of liquids. The two instruments differ in measuring precision. Both instruments:

- measure liquids whose refractive indices range respectively from 1.3200 to 1.7000 (RM40) and to 1.58000 (RM50).
- require only minimal sample quantities for measurements (0.5 mL),
- maintain the temperature of the sample constant with the aid of a built-in Peltier thermostat in a range from 5 to 100 °C (RM40) and 5 to 75 °C (RM40).
- directly indicate the sugar content of samples in various sugar units (Brix, invert sugar, HFCS42 or HFCS55)
- calculate the concentration of a solution by means of data from measured standard solutions, literature tables or formulas
- are equipped with an integrated test function that enables regular testing of the accuracy of the measurement,
- enable checking of the product-related specification limits and generate rolling statistics.

The samples can be introduced manually with a syringe. For the optimal use of the RM refractometers, the following pumps and sample changers are available:

- A peristaltic pump (FillPal):  
For the automatic filling, emptying and rinsing of the cell.
- The autosampler InMotion™  
The autosampler for a completely automatic measurement of up to 303 aqueous, low viscous samples in series.
- The automatic sample and cleaning unit (SC1):  
for fully automated measurements of free-flowing and viscous samples. The system automatically cleans and dries itself on completion of a measurement so that it is ready for the next measurement.
- The sample changer (SC30):  
The SC30 sample changer for the completely automatic measurement of up to 30 samples in series.

The following devices can be connected:

- Computer for operation under LabX
- External measuring cells:
  - METTLER TOLEDO DX40, DX45 or DX50 density - modules
  - METTLER TOLEDO RX40 or RX50 refractive index - modules
- Barcode reader for scanning sample data, set values of certified standards and for starting measurements
- finger print reader for user identification
- Compact printer (USB-P25), to print out results
- External instruments:
  - METTLER TOLEDO S20 – SevenEasy™ pH
  - METTLER TOLEDO S30 – SevenEasy™ Conductivity
  - METTLER TOLEDO S220 - SevenCompact™ pH/Ion
  - METTLER TOLEDO S230 - SevenCompact™ Conductivity
  - Lovibond colorimeters PFX880 / PFXi880, PFX950 / PFXi950 and PFX995 / PFXi995 series, Tintometer
  - Minolta colorimeters CM-5 / CR-5
- USB stick
- External sensors:
  - ErgoSens – Infrared movement sensor for the automatic start of measurements
  - LevelSens – Level sensor for waste bottle
  - AtmoSens – Air pressure sensor for measuring air pressure and taking the latter into account in adjustments and tests with air.

Special features of the refractometer:



- A maintenance-free LED is used as a light source for the measurements.
- The measuring prism is made of sapphire. It is therefore extremely corrosion resistance and very robust. It also has a high thermal conductivity.
- For temperature measurement, NTC thermistors with extreme long-term stability are used. This means that there is no need to regularly readjust the measuring cell.

### 3 Principles of Refractometry

#### 3.1 Definition of the Refractive Index

The refractive index of a substance is the ratio of the speed of a light beam in a vacuum to its speed in the substance (dimensionless).

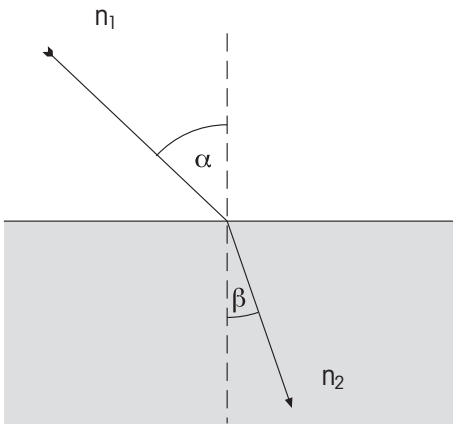

If a light beam crosses at a certain angle from an optically less dense to an optically denser medium (e.g. from air to water), it is deflected; when the beam crosses from one medium to another perpendicularly no directional change takes place. According to Snell's law, the ratio of the refractive index of the two media is proportional to the ratio of the incident and refractive angle of the light beam:

$$\frac{n_1}{n_2} = \frac{\sin \beta}{\sin \alpha}$$

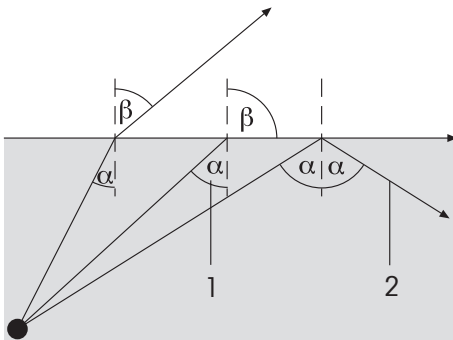

If a light beam passes from an optically denser to a less dense medium, it is also deflected. If the angle of incidence  $\alpha$  is increased, then it reaches a critical value, at which the light beam no longer enters the less dense medium (refractive angle  $\beta = 90^\circ$ ). When this "critical angle" is exceeded, total internal reflection occurs. The refractive index is calculated from this critical angle  $\alpha$  :

$$\beta = 90^\circ \rightarrow \sin \beta = 1$$

- 1: Critical angle
- 2: Total internal reflection

As refraction depends on the wavelength of the incident light, the refractive index  $n$  is measured as standard with the D line of sodium (wavelength 589.3 nm) and designated  $n_D$ .

The refractive index not only depends on the wavelength of the light but also on the temperature of the measured sample. For this reason the temperature must always be stated along with the result, e.g.  $n_D^{25}$ . The standard temperature is 20 °C.

#### 3.2 Method of Measurement

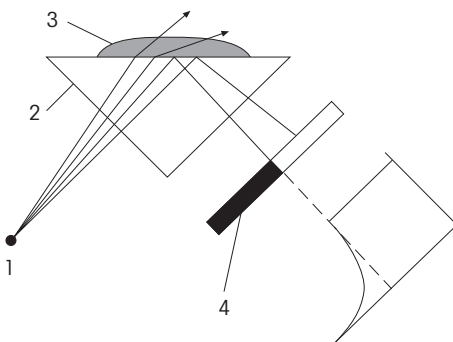

The light emitted from the light source passes through the prism and hits the sample. In the process it is partly refracted (angle of incidence < critical angle) and partly reflected (angle of incidence > critical angle).

The reflected light is measured by means of an optical sensor (CCD). The boundary between the dark and light area corresponds to the critical angle required for calculation of the refractive index.

- 1: Light source
- 2: Prism
- 3: Sample
- 4: Optical sensor (CCD)

#### 3.3 Design of Measuring Cell

The light source is a light-emitting diode (LED), whose beam passes through a polarization filter, an interference filter (589.3 nm) and various lenses before it reaches the sample via the sapphire prism. The reflected light (angle of incidence > critical angle) is deflected via a lens to the optical sensor that determines the critical angle. The temperature in the prism/sample boundary is measured with a built-in sensor.

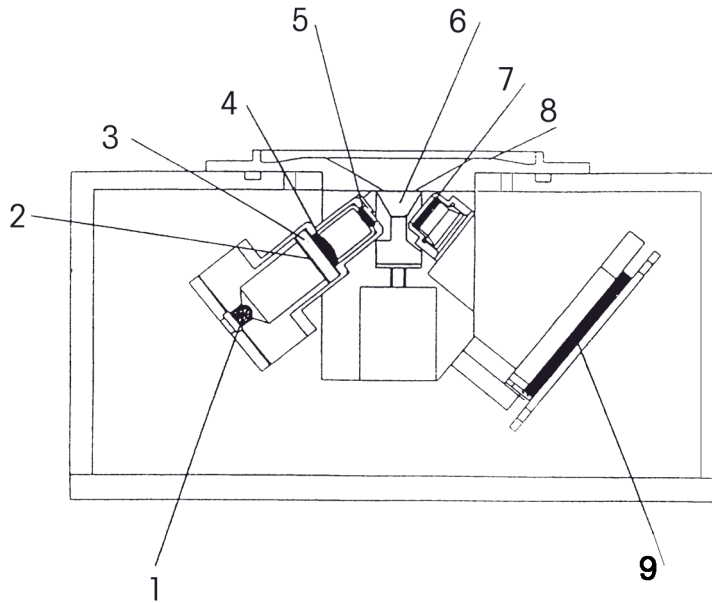

- 1: Light source
- 2: Polarization filter
- 3: Interference filter
- 4: Lens
- 5: Lens
- 6: Prism
- 7: Lens
- 8: Measuring cell
- 9: Optical sensor (CCD)

## 4 Description of Functions

### 4.1 Layout of the Terminal

The control panel of the terminal consists of an integrated touchscreen and the following buttons, located next to the touch-sensitive surface of the display: You can press these buttons any time, regardless of which dialog you are currently using.

- Two **Home** buttons that bring you back to the **Homescreen**.
- **Info**, opens the info screen that shows the data related to the specific device.
- **Reset** that interrupts the ongoing task and processing of the pending tasks. To continue the waiting tasks, open the task list (with the **Tasks** button) and click **Resume**.

### 4.2 Operating the Touchscreen

The touchscreen is automatically activated when the instrument is switched on.

To select a button or an input element in the dialog window, you simply touch the screen using a soft blunt object or a fingertip.

It is also possible to select input elements using a USB mouse. To do this, simply connect the mouse to a suitable USB port on the instrument.



Never touch the surface of the touchscreen with pointed or sharp objects! This may damage the screen!

### 4.3 Homescreen

**Home** is the first screen that is displayed when you start up the instrument or when you log in. **Home** is the main screen. On the left-hand side of the screen you will see five buttons that lead to the following dialog windows:

- **Methods / Products**: The button leads you to the method or product editor, in which you can create and administer the methods or products (see "Methods and Products").
- **Series**: In this dialog, you can create and manage series of individual samples, e.g. for using a sample changer (see "Series").
- **Results**: Here you administer the results of your analyses (see "Results and Statistics").
- **Setup**: You can administer the following points here:
  - Adjustment and test sets
  - The hardware and all resources used by the instrument
  - User and global settings
  - Tables (internal and user defined) and auxiliary values
  - Maintenance and service of the instrument
- **Manual**: This button takes you to manual operations.

In addition, there is another area that can be configured individually by each user (with the necessary authorization). Each user can store up to eight shortcuts here. With these shortcuts, defined methods, products, series and manual operations can be started directly from the homescreen (see "Functional Description"): The user interface > Shortcuts").



- **Standby display**: The standby display continuously shows the current cell temperature (Tcell) and set temperature (Tset), even if no task is running.

Via the standby display in the Homescreen you open the **Cell data** dialog.

- By pressing the home button on the control panel of the terminal, you return to **Home**.

#### See also

- Methods and Products (page 36)
- Series (page 60)
- Results and Statistics (page 62)
- Shortcuts (page 14)

## 4.4 The User Interface







The graphical user interface consists of the following five basic elements:

- The **title bar** at the top of the display specifies the name of the current dialog.
- In the top right-hand corner you will see **Tasks** button, which signals the presence of ongoing processes (see "Tasks and online screen: Tasks (page 73)").
- The **navigation bar**, located below the title bar, specifies the path to the current dialog.
- The **scroll bar** on the right-hand side of the screen becomes visible if the content of the screen extends beyond the viewable area. If this occurs, use either the arrows or the area in between them to move the viewable area of the screen up or down.
- Five **buttons** are located at the bottom of the screen. The function of these buttons varies and depends on the context of the current dialog.

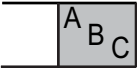
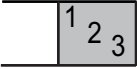
### 4.4.1 Entering Data in the User Interface.

There are different types of input fields in the user interface. They allow you to enter data or select data from a list. Input fields can also be deactivated and their contents are then displayed as information only and cannot be changed in the corresponding dialog.

The various types of input fields are identified by an icon to the right of the screen:

|                     |   |  |
|---------------------|---|--|
| Text input fields   |    | In these fields text can be freely entered.  |
| Number input fields |   | Numbers can be entered in these fields.  |
| Drop-down lists     |  | Selecting these fields opens a drop-down list from which you can select an entry.  |
| List fields         |  | Selecting these fields opens a menu list in a new window.  |
| Parameter field     |  | Selecting these fields opens a new dialog with various additional parameters.  |
| Formula fields      |  | Freely definable formulas can be entered in these fields   |
| Info field          |  | The values in deactivated input fields are displayed as information only and cannot be edited in the corresponding dialog. |



In addition to the input fields there are checkboxes that can be checked in order to select certain functionalities. Checkboxes can affect the scope of the corresponding dialog, i.e. input fields can be hidden or visible depending on whether the checkbox is checked.

## Sorting lists

There are lists that can be sorted alphabetically or numerically by column in ascending or descending order. To do this, simply touch the parameter in the header row by which you would like to sort the list. A small arrow in the header row indicates the parameter by which the list is sorted and whether it is sorted in ascending or descending order.

### 4.4.2 Shortcuts







Shortcuts allow you to start methods, series, and manual operations directly from the homepage. You can locate shortcuts by means of the button **AddToHome** on the Homescreen. **AddToHome** is found in the respective **Start analysis** dialog of the methods, products, series or of the manual operation.

Two types of shortcuts are supported.

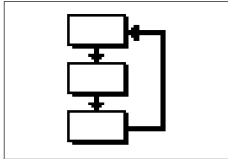
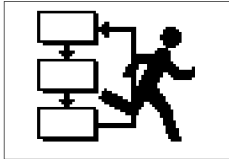
Direct shortcuts which, when selected, start the task immediately without warning (only if the other settings allow this), and

normal shortcuts which take you to the corresponding **Start analysis** start dialog from which you can start the task.

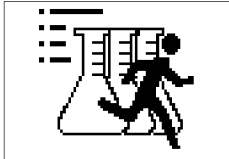
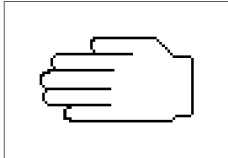
Shortcuts are user-specific, i.e. each individual user can create shortcuts for the tasks that they would personally like to conduct. Shortcuts are managed in Setup, under the subcategory "User Settings". Here you can delete or modify shortcuts, or change their position on the Homescreen.

|                       | <b>Shortcuts</b><br>(lead you initially to the <b>Start analysis</b> dialog)        | <b>Direct shortcuts</b><br>(task starts immediately, directly and without advance warning) |
|-----------------------|---|--|
| for methods           |   |         |
| for products          |  |        |
| for series            |  |        |
| for manual operations |  |        |



A maximum of 8 shortcuts can be saved on the Homescreen. As soon as this maximum is reached, "**AddToHome**" in the start dialogs of methods, products, series and manual operations is deactivated.

## 5 Setup

This section tells you how to set up the refractometer accordance with your requirements so that you can carry out the measurements.

The following summary shows the buttons available in **Setup** for the various setting options:

|                                  |  |
|----------------------------------|--|
| <b>Adjustments &amp; Tests</b>   | Adjustment sets                              |
|                                  | Test sets                                    |
| <b>Hardware</b>                  | Cell   |
|                                  | Automation                                   |
|                                  | External instruments                         |
|                                  | Peripherals                                  |
|                                  | Sensors                                      |
|                                  | Auxiliary instruments                        |
| <b>User settings</b>             | Language                                     |
|                                  | Screen                                       |
|                                  | Beep   |
|                                  | Shortcuts                                    |
|                                  | Keyboards                                    |
| <b>Global settings</b>           | System                                       |
|                                  | User management                              |
|                                  | Analysis and resources behavior              |
|                                  | Physical Properties                          |
| <b>Tables &amp; Values</b>       | Tables                                       |
|                                  | Auxiliary values                             |
| <b>Maintenance &amp; Service</b> | MT service                                   |
|                                  | Import / Export                              |
|                                  | Add external cell                            |
|                                  | Reset to factory settings                    |
|                                  | Firmware                                     |
|                                  | Update                                       |
|                                  | Hardware / Firmware summary                  |
|                                  | Cell   |
|                                  | Touch screen adjustment                      |
|                                  | Export of adjustments / Tests / Measurements |

### The "Expired Resources" button

The **Expired Resources** button is located on the setup overview screen. It provides you with a summary of all expired resources, stating the: type, name and expiration date of the respective resource.

Expired resources are entered if the setting "Monitoring adjustment set/test set/auxiliary value" is activated during setup.

Below you will find a detailed description of the setting options available in setup:

### 5.1 Adjustments & Tests

**Navigation:** Home > Setup > Adjustments & Tests

Adjustment and test sets can be administered as described below. You can create new sets and delete existing ones (when deleting you receive a prompt with the option to cancel). Before an adjustment or test can be performed, an adjustment or test set must be defined.

A maximum of six different adjustment sets or test sets respectively can be entered in the set list.

Before an adjustment or test can be performed, an adjustment or test set must be defined.

## 5.1.1 Adjustment Sets

Via the button **Adjustment sets** you will obtain a list of the defined sets. The default set "Air&Water20.00C" is always available and cannot be deleted. When you click the sets, you obtain more detailed information about the individual sets. The parameters "Adjustment mode", "Temperature" and "Set name" are displayed.

### Creating adjustment sets

You can create your own adjustment sets via the button **New**. The **Adjustment set parameters** dialog opens.

| Parameters      | Description  | Displayed if |
|-----------------|--|--------------|
| Adjustment mode | Defines with which standard the adjustment will be performed.<br>Set "Standards" requires a valid adjustment with "Air&Water" at this temperature. (set "Air&Standard" and set "Water&Standard" are not available for refractometers). | -            |
| Temperature     | Defines at which temperature the adjustment will be performed.   | -            |
| Set name        | The set is uniquely identified in the system via this name.  | -            |

### Delete adjustment sets

- 1 To delete a created set, click the desired entry in the **Adjustment sets** dialog.
- 2 In the **Adjustment set parameters** dialog, click the button **Delete**.  
⇒ When a set is deleted, the set history will also be deleted. Methods that refer to the deleted set are no longer executable.

## 5.1.2 Test Sets

Via the button **Test sets** you receive a list of the defined sets. The default set "Water20.00C" is always available and cannot be deleted. When you click the test sets, you obtain more detailed information about the individual sets. The parameters "Test mode", "Temperature", "Set name" and depending on the mode "Standard name" are displayed.

### Creating test sets

You can create your own test sets via the button **New**. The **Test set parameters** dialog is opened.

| Parameters    | Description   | Displayed if                                |
|---------------|---|---|
| Test mode     | Defines with which standard the test will be performed.     | -   |
| Temperature   | Defines at which temperature the test will be performed.    | -   |
| Standard name | Description of the standards                                | "Test mode" = "Standard" or "Brix standard" |
| Set name      | The set is uniquely identified in the system via this name. | -   |

### Delete test sets

- 1 To delete a created set, click the desired entry in the **Test sets** dialog.
- 2 In the **Test set parameters** dialog click the button **Delete**.  
⇒ When a set is deleted, the set history will also be deleted. Methods that relate to the deleted set are no longer executable.

## 5.2 Hardware

**Navigation:** Setup>Hardware

In this dialog window you can configure all the hardware components connected to the meter. These include:

- Cell
- Automation
- External instruments
- Peripherals
- Sensors
- Auxiliary instruments



## 5.2.1 Cell

**Navigation:** Home > Setup > Hardware > Cell

The measuring cell is connected via an internal interface in the compact device. The instrument can be extended to create a 2-cell instrument (see also "Setup: Maintenance & Service > Add external cell (page 33)").

- Touch the button **Cell** in the **Hardware** dialog.
  - ⇒ With single cell instruments you go directly to the list with the cell parameters
  - ⇒ In the case of two cell instruments the connected cells are listed. You have to touch one of the displayed cells so that the **Cell parameters** dialog opens.
  - ⇒ The **Cell parameters** dialog is opened.

| Parameters    | Description                          | Displayed if |
|---------------|--------------------------------------|--------------|
| Cell          | Name of the measuring cell           | -            |
| Type          | Measuring cell type                  | -            |
| Status        | Shows whether the cell is connected. | -            |
| Serial number | Serial number of the cell            | -            |

If an adjustment has been performed, an entry in the adjustment set appears in the setup of the corresponding cell. If you touch the entry, the data of the most recent adjustment that was executed with the set will be displayed.

| Parameters                | Description  | Displayed if                                     |
|---------------------------|--|--|
| Adjustment set            | By touching the set entry, you obtain the values for the most recent adjustment of this set.   | -  |
| Monitoring adjustment set | Monitoring of the service life of the adjustment can be activated. The process, if the service life of a set has expired, is defined in the method function "Measure". | -  |
| Adjustment interval       | Validity of adjustment   | "Monitoring adjustment set" activated            |
| Reminder                  | Before the set expires, a message appears indicating that the adjustment or test has expired.  | "Monitoring adjustment set / test set" activated |
| Days before expiration    | Specifies the number of days after which a warning is triggered.   | "Reminder" activated                             |

If a test has been performed, an entry in the test set appears in the setup of the corresponding cell. If you touch the entry, the data of the most recent adjustment that were executed with the set will be displayed.

| Parameters             | Description  | Displayed if                                     |
|------------------------|--|--|
| Test set               | By touching the set you go to the values for the most recent test for this set.  | -  |
| Monitoring test set    | Monitoring of the service life of the test can be activated. The process, if the service life of a set has expired, is defined in the method function "Measure". | -  |
| Test interval          | Service life of test   | "Monitoring test set" activated                  |
| Reminder               | Before the set expires, a message appears indicating that the adjustment or test has expired.  | "Monitoring adjustment set / test set" activated |
| Days before expiration | Specifies the number of days after which a warning is triggered.   | "Reminder" activated                             |

Via the button **History** you go to a list that contains a maximum of ten adjustment or test entries for the selected set. In the process the measured refractive index values are displayed (in the adjustment mode air and water only the value for water). The history can be displayed in graphic form via the button **Graph**. You can view the history data by touching an entry.

## 5.2.2 Automation

**Navigation:** Home > Setup > Hardware > Automation

The automation units that can be installed are listed below:

- DryPal (drying pump)
- FillPal (sample pump)
- SC1 (automation unit for a sample)
- SC30 (automation unit for 30 samples)
- InMotion (automation unit for up to 303 samples)

The peripheral devices have an automatic PnP (Plug and Play) – identification. They can also be manually created in the setup.

Via the button **Automation** in the **Hardware** dialog, you access a list with defined automation units. By touching a list entry, you obtain more detailed information about the corresponding automation unit.

| Parameters           | Description   | Displayed if                    |
|----------------------|---|---------------------------------|
| Type                 | Instrument Type   | -                               |
| Power purge unit     | The external diaphragm (Optional) has a much higher output than the diaphragm pump integrated in the SC1/SC30. The pump is actually adjusted at the SC1/SC30. | "Type" = "SC1" / "SC30"         |
| Heating option       | This is where the heating option is activated. The temperature is directly set on the heating unit.   | "Type" = "SC1" / "SC30"         |
| Limit sensor         | Optical sensor that detects the sample and prevents it leaving the heated area of the heating option (info field).  | "Type" = "SC1" / "SC30"         |
| External drain valve | Located in the heating unit. Prevents the samples flowing back after filling process (info field).  | "Type" = "SC1"/"SC30"           |
| Solvent 1            | Specifies the solvent at the connection Rinse 1   | "Type" = "SC1" / "SC30"         |
| Solvent 2            | Specifies the solvent at the connection Rinse 2   | "Type" = "SC1" / "SC30"         |
| Speed "Low"          | Value for speed level "Low" of the FillPal or InMotion autosampler (in % of the maximum speed).   | "Type" = "FillPal" / "InMotion" |
| Speed "Medium"       | Value for speed level "Medium" of the FillPal or InMotion autosampler (in % of the maximum speed).  | "Type" = "FillPal" / "InMotion" |
| Speed "High"         | Value for speed level "High" of the FillPal or InMotion autosampler (in % of the maximum speed).  | "Type" = "FillPal" / "InMotion" |
| Rate at 100%         | Value for max. possible pump output (depending on the installed pump which is defined as sampling pump).  | "Type" = "InMotion"             |
| Stirrer output       | Specifies the pump/stirrer port on the InMotion where your stirrer is connected.  | "Type" = "InMotion"             |
| Sampling pump output | Specifies the pump/stirrer port on the InMotion where your sampling pump is connected.  | "Type" = "InMotion"             |
| PowerShower output   | Specifies the pump/stirrer port on the InMotion where your pump for PowerShower is connected.   | "Type" = "InMotion"             |
| Rate                 | Value for required pump output for PowerShower.   | "Type" = "InMotion"             |
| Beaker height        | Specifies the height of the used beakers.   | "Type" = "InMotion"             |

A distinction should be made between the following two cases in the installation of instruments:

1. There is still no setup entry available in the unit (delivery state).  
A new entry has been generated and the parameters automatically generated.
2. A setup entry was previously manually created in the instrument:  
The PnP parameters are automatically entered, the remaining parameters, previously edited by the user, remain unchanged.

When a PnP instrument is unplugged, the status changes to "not installed".

Below is described how you can administer the various devices in setup. This includes the creation of devices or changing the parameters in the setup.

### Create automation units

So that methods for the application of automation units can be created and configured without the automation unit being connected, these units must be created in the setup via the button **New**.

### Delete automation unit

It is not possible to delete the entry of a connected device.



If you want to delete an entry for a unit that is not connected from the list, a message with the termination option appears indicating that after deletion the methods that use the external instruments will no longer be executable.

## 5.2.3 External Instruments

**Navigation:** Home > Setup > Hardware > External instruments

The external instruments that can be installed are listed below. They all have automatic PnP – identification:

- METTLER TOLEDO S20 – SevenEasy™ pH
  - METTLER TOLEDO S30 – SevenEasy™ Conductivity
  - METTLER TOLEDO S220 - SevenCompact™ pH/Ion
  - METTLER TOLEDO S220 - SevenCompact™ Conductivity
  - Lovibond colorimeters PFX880 / PFXi880, PFX950 / PFXi950 and PFX995 / PFXi995 series, Tintometer
  - Minolta colorimeters CM-5 / CR-5
-  • The Lovibond colorimeters can be connected to the USB interfaces. For this purpose the USB – RS232 adapter is required (contained in the connection kit).
- For each device type only one entry is possible.

### Install devices

A distinction should be made between the following two cases in the installation of instruments:

1. There is still no setup entry available in the unit (delivery state).  
A new entry has been generated and the parameters automatically generated.
2. A setup entry was previously manually created in the instrument:  
The PnP parameters are automatically entered, the remaining parameters, previously edited by the user, remain unchanged.

When a PnP instrument is unplugged, the status changes to "not installed".

- Via the button **External instruments** in the **Hardware** dialog, you can obtain the list of instruments. By touching a list entry, you obtain more detailed information about the corresponding instrument.

### Create device

So that methods can be created and configured with external instruments, without having to connect the instrument, the setup entries of the external instruments can be manually created via the button **New**.



- The pH and conductivity meters can be assigned names individually using the "Instrument" parameter.

### Delete devices

It is not possible to delete the entry of a connected device.



If you want to delete an entry for a unit that is not connected from the list, a message with the termination option appears indicating that after deletion the methods that use the external instruments will no longer be executable.

### SevenEasy™ / SevenCompact™ pH/ion and conductivity meters

- 1 Select the following for the SevenEasy™ and SevenCompact™ measuring instruments (also refer to the operating instructions for the measuring instrument concerned):
  - Manual end point measured value acquisition,
  - set the unit [pH]" ([mV] not supported).
- 2 For the SevenCompact pH and conductivity meters, the following must also be selected (also refer to the relevant operating instructions):
  - an interval time of 1 s (in menu>Interval measurements),
  - interface=printer (in menu>Data transmission),
  - "Send data to interface" (in "Type of data transmission").

- 3 For temperature compensation, set the unit [°C] at the measuring instruments. Two types of temperature compensation exist:
- ATC (automatic temperature compensation) with a temperature sensor connected.
  - MTC (manual temperature compensation) with no temperature sensor connected.

**Note:**

The pH or conductivity meters switch automatically, depending on the arrangement.

If the temperature unit at the pH meter or conductivity meter is set to [°C], the results "TpH" and "TCond" will be converted to the temperature unit set in the instrument, i.e. either [°C] or [°F]. By contrast, if [°F] is set at the pH or conductivity meter, no result will be calculated. "--" will be output in the results field.

- i** The conductivity units are [mS/cm] / [µS/cm] (depending on the range) or [mS/m] [µS/m] (depending on the range). However, the results are expressed in [µS/cm]. If you wish to have the result displayed in [mS/cm] or [mS/m] [µS/m], it will be necessary to recalculate the result using the "Calculation" method function.

### Colorimeter

#### - Lovibond

The Lovibond colorimeter can be used for extinction or transmission measurements. The wavelengths are output in 5 nm (in the range 420 – 710 nm).

- i** A color measurement may take longer than 25 s.

#### - Minolta colorimeters CM-5 / CR-5

The Minolta colorimeters can be used for transmission measurements (liquids).

Transmission data are supplied in 10 nm increments within the spectral range 360 – 740 nm.

A color measurement takes approximately 1 s.

The measurements involve high-energy light flashes. For this reason, color scales are not offered for reflection measurements in the crude oil industry.

- i**
- The CR-5 colorimeter does not supply any spectral data.
  - Calibration is possible directly at the colorimeter only. The USB link must be disconnected.
  - "Illuminant" and "Observer" can be set in the "Configuration" method function. For more information, see "Methods and products: Method functions > Configuration (page 42)".

#### - Color scales

**Navigation:** Home > Setup > Hardware > External instruments > Parameters

– Click on "Colorimeter".

⇒ The "External instrument parameters" dialog appears.

If a device has been connected, a list of color scales is displayed via the **Color scales** button, that were available in the most recently connected device. If the device has been manually configured and no device has yet been connected, then the list is empty.

#### See also

- Continuous run (page 71)

## 5.2.4 Peripherals

**Navigation:** Home > Setup > Hardware > Peripherals

In the dialog **Peripherals**, the following devices and settings can be configured:

- Barcode reader
- USB stick
- Fingerprint reader
- Printer
- Personal Computer (PC) – settings
- Network settings
- Network storage

Below is described how you can administer the various devices in setup. This includes the creation of devices or changing the parameters in the setup.

## Barcode reader

Barcode readers have Plug&Play (PnP) recognition and can be installed via the USB interface.

The following barcode readers can be installed:

- Handheld readers
- Built-in readers

You can create the barcode readers via **New**. A maximum of one entry can be created for both types.

| Parameters            | Description  | Displayed if   |
|-----------------------|--|--|
| Type                  | Instrument Type  | -  |
| Serial number         | Serial number of the corresponding device  | -  |
| Barcode Information   | Sample ID: on the barcode there is only the sample ID.<br>Method ID: on the barcode there is the method ID (with this a saved method can be selected during scanning).<br>Product ID: on the barcode there is the product ID (with this a saved product can be selected during scanning).<br>Sample ID/Method ID: on the barcode there are the sample ID and method ID (with this a saved method can be selected during scanning).<br>Sample ID/Product ID: on the barcode there are the sample ID and product ID (with this a saved product can be selected during scanning). | -  |
| Start pos. sample ID  | Start position of the sample ID on the barcode   | "Barcode information" with sample ID   |
| Number of characters  | Length of the sample ID on the barcode   | "Barcode information" with sample ID   |
| Start pos. method ID  | Start position of the method ID on the barcode   | "Barcode information" with method ID   |
| Number of characters  | Length of the method ID on the barcode   | "Barcode information" with method ID   |
| Start pos. product ID | Start position of the product ID on the barcode  | "Barcode information" with product ID  |
| Number of characters  | Length of the product ID on the barcode  | "Barcode information" with product ID  |
| Immediate start       | If this parameter has been activated, when a task is started with the barcode reader, the <b>Start analysis</b> dialog is skipped and the task is started immediately.   | "Type" = "Handheld reader",<br>"Barcode information" with method ID, product ID or sample ID |

Example of barcode with sample ID and method ID (161218522). (Sample ID=1612 and method ID 18522).

- Start pos. sample ID 1
- Number of characters 4
- Start pos. method ID 5
- Number of characters 5

## USB stick

Commercially available USB sticks from USB Version 1.1 are supported.

## Fingerprint reader

You can use a fingerprint reader to authenticate users on the titrator. In order to do this, the fingerprint reader must be activated on the titrator. The following parameters are available for this:

| Parameters                  | Description                                 | Displayed if |
|-----------------------------|---|--------------|
| Activate fingerprint reader | Activates the connected fingerprint reader. | -            |

## Printer (and USB-RS232 data export)

- Date can be printed with the USB-P25 (strip printer) or with a network printer.
- Data can be exported using the USB data export box. The data are exported in the XML (UTF-8) formats.
- For data export to an RS interface, you need the USB RS232 adapter (USB data export box).
- As desired, data can be printed either as a summary or in a user defined format (via "Print Mode" parameter "Report" method function; also see "Methods and products: Methods > Method functions > Report")

i

For printing/USB data export, the following should be taken into consideration:

i

- In the "Report" method function, the "Print / USB-RS232 data export" parameter must be selected.

You can define the following parameters via the **Printer** button (Home > Setup > Hardware > Peripherals):

| Parameters   | Description   | Displayed if  |
|--------------|---|---|
| Printer type | <p><b>USB compact printer</b><br/>The USB compact printer does not support all languages. This printer can only print out a limited quantity of analysis data and results.</p> <p><b>USB-RS232 data export</b><br/>For the RS-232 data export, the data is transmitted regardless of the selected language. Only a limited quantity of data and results can be exported.</p> <p><b>Network printer</b><br/>Every connected printer in your local network that supports HP PLC 3 or Epson ESC/P 2 can be used.</p> | -   |
| Status       | Indicates whether the selected printer type is installed (info field).  | Only for printer type "USB compact printer" and "USB-RS232 data export" |
| Baud rate    | The baud rate for data transmission via the USB-RS232 interface.  | "Printer type" = "USB-RS232 data export"                                |
| Data bit     | The number of data bits is displayed (info field).  | "Printer type" = "USB-RS232 data export"                                |
| Stop bit     | The number of stop bits is displayed (info field).  | "Printer type" = "USB-RS232 data export"                                |
| Parity       | Defines the parity protocol. ("Even", "Odd", "None") .  | "Printer type" = "USB-RS232 data export"                                |
| Handshake    | Data transmission via the RS-232 interface ("Xon-Xoff", "None").  | "Printer type" = "USB-RS232 data export"                                |
| Type         | Choose the printer protocol.  | "Printer type" = "Network printer"                                      |
| Network name | Define your local network name here.  | "Printer type" = "Network printer"                                      |
| Port number  | Define your local port number here.   | "Printer type" = "Network printer"                                      |
| Paper size   | Choose the print-format of the report (A4 / Letter).  | "Printer type" = "Network printer"                                      |

## PC settings

Only one PC connected per measuring instrument can be present at one time. You can select if you wish to set up a connection to the laboratory program "LabX".

| Parameters                            | Description  | Displayed if |
|---------------------------------------|--|--------------|
| Set up connection to LabX at start up | If this parameter is activated, a connection to LabX will be established on startup. | -            |

i

Changes to the PC settings are not implemented until after the measuring instrument is rebooted.

## Network settings

You can define the following parameters for the network – settings:

| Parameters                      | Description  | Displayed if        |
|---------------------------------|--|---------------------|
| Type                            | Type of network connection   | -                   |
| Obtain IP address automatically | If this device has been activated, the device automatically obtains an IP address. | "Type" = "Ethernet" |
| IP Address                      | IP address of the instrument   | -                   |
| Subnet mask                     | Subnet mask of the device  | -                   |
| Standard gateway                | Standard gateway of the device   | "Type" = "Ethernet" |



The device automatically reboots after any change to the network settings.

## Network storage

You can define the following parameters for a network – storage:

|                     |  |                                  |
|---------------------|--|----------------------------------|
| Transfer via        | Method for transferring data<br>Default: Network share   | -                                |
| Server              | PC or server name. Users should have read-write access. Maximum 60 alphanumeric characters.<br>Arbitrary IP address or name of server (for network share, only server name allowed).   | -                                |
| Share name          | Name of the share folder   | -                                |
| User name           | Define your own user name.   | -                                |
| Domain              | Domain name for the user.  | -                                |
| Password            | Password for network share.  | -                                |
| Target folder       | Name of target folder for PDFs or results.<br>A <b>pdf_export</b> folder and a <b>results</b> folder are automatically created in the target folder when specified. If no target folder is specified the folders are created in the root folder. | -                                |
| First folder level  | Can optional be used to sort data. (None   User name   Instrument ID   Date   Method ID   Analysis comment)<br>Default: None   | -                                |
| Second folder level | Can optional be used to sort data. (None   User name   Instrument ID   Date   Method ID   Analysis comment)<br>Default: None   | "First level folder" = activated |

## 5.2.5 Sensors

**Navigation:** Home > Setup > Hardware > Sensors

Sensors can be activated in the setup. The following sensors can be connected:

**ErgoSens:** Infrared sensor for contactless start of measurement (see "Analysis sequence: Start of analyses").

Before you can use ErgoSens, it has to be activated:

| Parameters        | Description            | Displayed if |
|-------------------|------------------------|--------------|
| Activate ErgoSens | Activates the ErgoSens | -            |

**WasteSens** or **LevelSens:** Level sensors for waste bottle.

It is determined whether the maximum filling level of the waste bottle is reached. If the maximum filling level has been reached, a message appears prompting the operator to empty the waste bottle. The task is then interrupted.

Before you can use WasteSens or LevelSens, it has to be activated:

| Parameters                   | Description                          | Displayed if |
|------------------------------|--------------------------------------|--------------|
| Activate WasteSens/LevelSens | activates the WasteSens or LevelSens | -            |

If you connect the density - module, you can use an air pressure sensor:

**AtmoSens:** Atmospheric pressure sensor for measuring the absolute air pressure.

If an AtmoSens is connected, the atmospheric pressure (if required) is measured with the AtmoSens. If no AtmoSens is connected, the air pressure is read out from the current value from `Home > Setup > Global settings > Physical properties`.

| Parameters                   | Description   | Displayed if |
|------------------------------|---|--------------|
| Verify AtmoSens availability | If this parameter is activated, the use of the AtmoSens is enforced for tasks which require the pressure. | -            |

## 5.2.6 Auxiliary instruments

**Navigation:** `Setup>Hardware>Auxiliary Instruments`

Auxiliary instruments can be any instruments that access the 24V output or USB-RS232 adapter of the measuring instrument and that are to be used in a method.

An auxiliary instrument that accesses the 24 V output is switched on for a predefined period and then switched off again via the corresponding command. The instruments are controlled via the "Auxiliary instrument" method function.

Auxiliary instruments form part of a method, while peripheral devices are classified as input/output devices (printers, barcode readers etc.), which do not have direct access to methods.

Starting from the auxiliary instrument list, you can add new auxiliary instruments or select existing ones or modify their parameters. In addition, the selected auxiliary instruments can be deleted.

**i** A maximum of 30 auxiliary instruments can be entered.

► Choose the **New** button in the **Auxiliary Instruments** dialog window to open the **Auxiliary Instrument Parameters** dialog.

1 Before a new auxiliary instrument can be added, you must first use the "Control type" parameter to select the manner in which the auxiliary instrument is to be controlled:.. The following values are available for "Control type":

- ⇒ 24V output
- ⇒ USB-RS-232

2 You can assign a name of your choice to the auxiliary instrument.

The parameters for the control types are listed below:

### 24V output

| Parameters   | Description  | Displayed if |
|--------------|--|--------------|
| Control type | Indicates which port on the measuring instrument is to be used for the auxiliary instrument. | -            |
| Name         | A name of your choice.   | -            |

### USB-RS-232 interface

| Parameters   | Description   | Displayed if                 |
|--------------|---|------------------------------|
| Control type | Indicates which port on the measuring instrument is to be used for the auxiliary instrument.  | -                            |
| Name         | A name of your choice.  | -                            |
| Adapter      | Defines which adapter is used. Maximum 2 auxiliary instruments of type USB-RS-232 can be used in the same method (by using adapter 1 and 2) | "Control type" = "USB-RS232" |
| Baud rate    | The baud rate for data transmission via the RS-232 interface of the adapter.  | "Control type" = "USB-RS232" |
| Data bit     | Defines the number of data bits.  | "Control type" = "USB-RS232" |



|           |  |                              |
|-----------|--|------------------------------|
| Stop bit  | Defines the number of stop bits. (2 stop bits can only be selected if 7 data bits are also selected at the same time.) | "Control type" = "USB-RS232" |
| Parity    | Defines the parity protocol.   | "Control type" = "USB-RS232" |
| Handshake | Data transmission via the RS-232 interface of the adapter.   | "Control type" = "USB-RS232" |



A suitable adapter (USB data export box) is required for the USB-RS-232 connection.

## 5.3 User settings

Navigation: > >

These settings contains the options that can be made specifically for each currently logged in user.

You can configure the language, the screen settings (for the touchscreen), the layout of the alphanumeric and numeric keyboard, the use of beeps, and shortcuts for each user.

### 5.3.1 Language

**Navigation:** Home > Setup > User settings > Language

The following languages are available:

- German
- English
- French
- Italian
- Polish
- Portuguese
- Spanish
- Chinese
- Russian

The language can be defined both for the operation of the terminal as well as for the protocols that are to be printed out from a printer.

| Parameters  | Description                    | Displayed if |
|-------------|--------------------------------|--------------|
| Touchscreen | Language of the user interface | -            |
| Report      | Language of the printout*      | -            |



\*Chinese can not be selected as language for reports

### 5.3.2 Screen

**Navigation:** Home > Setup > User - settings > Screen

The following parameters can be set in the screen settings:

| Parameters    | Description                              | Displayed if           |
|---------------|--|------------------------|
| Primary color | Color of the user interface              | -                      |
| Brightness    | Brightness of the display                | -                      |
| Button shape  | Shape of buttons on the touchscreen      | -                      |
| Screen saver  | Activates screen saver                   | -                      |
| Wait time     | Time for the display of the screen saver | Activates screen saver |

### 5.3.3 Beep

**Navigation:** Home > Setup > User settings > Beep

The audio signal is set specifically for each user. You can activate the audio signal in the **Audio-Signal settings** dialog.

| Parameters | Description | Displayed if |
|------------|-------------|--------------|
|------------|-------------|--------------|

### 5.3.4 Shortcuts

**Navigation:** Home > Setup > User - settings > Shortcuts

In this dialog, every user has the opportunity to administer his or her own selected shortcuts. The list of all shortcuts for the logged in user can be viewed. Individual shortcuts can be selected and deleted. You can determine the following parameters:

| Parameters          | Description   | Displayed if |
|---------------------|---|--------------|
| Description         | This text is the name of the shortcut that is displayed in the Homescreen.  | -            |
| Immediate start     | When the shortcut is pressed, the display switches directly over to the online screen without opening the <b>Start analysis</b> dialog. | -            |
| Homescreen Position | Selection of the position on the Homescreen   | -            |

### 5.3.5 Keyboards

**Navigation:** Home > Setup > User - settings > Keyboards

In the **Keyboard settings** dialog, you can define the layout for the alphanumeric and the numeric input fields. The following settings are available:

| Parameters   | Description  | Displayed if |
|--------------|--|--------------|
| ABC keyboard | Defines the layout of the alphanumeric input field.              | -            |
| 123 keyboard | Defines the arrangement of the keys for the numeric input field. | -            |

## 5.4 Global Settings

**Navigation:** Home > Setup > Global setting

In the **Global Settings**, you can make general settings to the measuring instrument that apply to all users of the instrument. The settings in this dialog can only be changed by users with the appropriate authorizations.

Global settings include:

- The **system settings**
- **User management** for creating user accounts and assigning rights.
- The settings for **Analysis and resources behavior**.
- **Physical properties** for defining the "Temperature unit" and the air pressure.

### 5.4.1 System

**Navigation:** Home > Setup > Global settings > System

In the **System settings** dialog the following buttons are available:

- **Identification:** In this menu you can give the measuring instrument a freely definable ID consisting of at least four characters.  
In addition the following information is displayed: Device, serial number and firmware version.
- **Date / time:** You can define the format used to display the date and time and set the device date and time.
- **Data storage:** If this parameter is activated, all results that are saved under Home > Results are deleted (only when device is shut down).

### 5.4.2 User Management

**Navigation:** Home > Setup > Global settings > User management

By means of the **User management** dialog you can administer users and account policies for the instrument. A maximum of 30 different users can be defined, from which only maximum one may be logged in with the instrument (1 user operation).

User accounts can be deleted and edited.

There is a default user with the user name "Administrator" (user group: Administrators). This cannot be deleted.

### 5.4.2.1 Users

**Navigation:** Home > Setup > Global settings > User management > User

Via the button **New** in the **User** dialog you can open the **User parameters** of the dialog. It is possible to define new users here.

**i** "User management" is the only area in which users with administrator rights are able to edit settings and, therefore, create or make changes to users.

Create a new user in the **User parameters** dialog as follows:

- 1 Define a user name.
- 2 Assign the user to a group. The following user groups are available:
  - Administrator
  - Expert
  - Technician
  - Operator

**i** For information on the rights of these user groups, see "Setup (Setup: Global settings > User management > User groups (page 27)".

The following parameters are available in the **User parameters** dialog:

| Parameters              | Description  | Displayed if                             |
|-------------------------|--|--|
| User name               | The user is uniquely identified in the system via the name.  | -  |
| Full Name               | Complete name of the user.   | -  |
| User Group              | Selection of the user group for the user. Depending on the user group the user has various rights. | -  |
| Reset password          | Resets the password for the user to "123456".  | Activates "Enforce password/fingerprint" |
| Lock user               | Locks the user.  | Activates "Enforce password/fingerprint" |
| Enforce password change | With the next login the entry of a new password will be enforced.                                  | Activates "Enforce password/fingerprint" |
| Created by              | The administrator logged in at time of creation  | -  |
| Created on              | Date of creation and time (info field)   | -  |
| Modified by             | The administrator logged in at time of creation  | -  |
| Modified at             | Change date and time (info field)  | -  |

### 5.4.2.2 Account Policy

**Navigation:** Home > Setup > Global setting > User management > Account policies

The following parameters can be edited in the dialog:

| Parameters                     | Description   | Displayed if                             |
|--------------------------------|---|--|
| Enforce password / fingerprint | If this parameter has been activated, you can only log in by entering the password (or via the fingerprint reader, if the parameter "Activate fingerprint reader" is activated, in Home > Setup > Hardware > Peripherals > Fingerprint reader). | -  |
| Min. password length           | The minimum length of the user passwords  | Activates "Enforce password/fingerprint" |

If the parameter "Enforce password" is deactivated, then the instrument starts directly, i.e. not via the login screen (only if one user is defined – corresponds to the factory settings). If several users are defined, the user name can be selected in the login screen from a list.

### 5.4.2.3 User Groups

Each user is assigned to a user group. The following four user groups (with decreasing rights going downward) should be distinguished:

- Administrator
- Expert

- Technician
- Operator

The following table presents the user rights that are assigned to the corresponding user group:

#### List of user rights

| Right   | Minimum required user group |
|---|-----------------------------|
| Start analysis via Shortcuts.   | Operator                    |
| Start analysis via <b>Start</b> button in the Homescreen  | Operator                    |
| Start analysis with ErgoSens  | Operator                    |
| Start analysis from method editor (for method type: measurement, cleaning and test), product and series editor (for method type: measurement, cleaning, test and adjustment)  | Technician                  |
| Adding/deleting items for series in the <b>Start analysis</b> dialog (does not apply for adjustment-type methods)   | Technician                  |
| Executing manual operations   | Technician                  |
| Editing shortcuts<br>(Setup>User settings)  | Technician                  |
| Including and excluding results   | Technician                  |
| Deleting results  | Expert                      |
| Adding/deleting items for series in the <b>Start analysis</b> dialog (also applies for adjustment-type methods)   | Expert                      |
| Setting the language for touchscreen and reports  | Expert                      |
| Start analysis from method editor (for method type: measurement, cleaning, test and adjustment)   | Expert                      |
| Editing methods, products, series   | Expert                      |
| Editing "Adjustments & Tests"<br>(Home > Setup)   | Expert                      |
| Editing "Hardware"<br>(Home > Setup)  | Expert                      |
| Editing "Analysis and resources behavior"<br>(Home > Setup > Global setting)  | Expert                      |
| Editing "Tables & Values"<br>(Home > Setup)   | Expert                      |
| Setting the language for reports  | Expert                      |
| Editing "Physical properties"<br>(Home > Setup > Global setting)  | Expert                      |
| Running "Maintenance & Service" in Home > Setup, <b>except</b> : <ul style="list-style-type: none"> <li>• Importing/exporting user management and memory copy</li> </ul>      | Expert                      |
| Running "Maintenance & Service"<br>(Home > Setup), <b>including</b> : <ul style="list-style-type: none"> <li>• Importing/exporting user management and memory copy</li> </ul> | Administrator               |
| Editing "User management"<br>(Home > Setup > Global setting)  | Administrator               |

### 5.4.3 Analysis and Resources Behavior

**Navigation:** Home > Setup > Global settings > Analysis and resources behavior.

The following settings can be defined:

| Parameters                                     | Description   | Displayed if |
|--|---|--------------|
| Show required resources at start               | If this parameter is activated, all resources are shown during startup that are required for performance of the analysis.<br><b>Note:</b> If a required resource is not available, the "Needed resources" dialog is also shown without this parameter having been activated.                            | -            |
| Confirm end of the analysis                    | If this parameter is activated, the <b>OK</b> button is shown at the end of the task. The task is not ended until you confirm with <b>OK</b> . This parameter is especially used if the result should remain on the online screen at the end of the measurement so that, for example, it can be copied. | -            |
| Reset statistics if sample ID changes          | If this parameter is activated, the rolling statistics will be interrupted, if the sample ID differs from the previous analysis. If it is not activated, the rolling statistics will only be interrupted if the method ID (or product ID) differs from the previous analysis.                           | -            |
| Verify USB stick availability                  | If this parameter is activated and a USB stick is used in the method, the task will be checked when the start is started to see if the USB stick is available. If none is available the task cannot be started.   | -            |
| Verify printer availability                    | If this parameter is activated and a printer is used in the method, the task will be checked when the task is started to see if the printer is available. If the printer is not available the task cannot be started (does not work for network printers).  | -            |
| Information on identification of PnP resources | If this parameter is activated, a message is shown when a PnP resource is detected.   | -            |
| Verify network storage availability            | If this parameter is activated and network storage is used in the method, the task will be checked when the task is started to see if a network storage is available. If no network storage is available, the task cannot be started.   | -            |

#### 5.4.4 Physical Properties

**Navigation:** Home > Setup > Global setting > Physical properties

In the **Physical properties** dialog you can defined the parameters "Temperature unit" [°C] or [°F] and "Atmospheric pressure" in [hPa].

| Parameters           | Description  | Displayed if |
|----------------------|--|--------------|
| Temperature unit     | Temperature unit applicable for all ranges of the instrument (global setting). Either Celsius or Fahrenheit can be selected. All inputs or outputs are in the temperature unit selected here. The setting is saved after a restart.                          | -            |
| Atmospheric pressure | Input of atmospheric pressure that is used for calculating the nominal value of the air density. The atmospheric pressure is required for an adjustment or a test with air or a cell test. If the AtmoSens is connected, the reading will be displayed here. | -            |



The atmospheric pressure is only required when using the density - module.

#### 5.5 Tables & Values

**Navigation:** Home > Setup > Tables & values

The instrument has tables and auxiliary values that can be used for the calculation of results (see also "Results (page 62)").

With measurements the raw data (e.g. temperature value and refractive index) are delivered. These results are fed into the relevant tables so that corresponding results can be displayed in the respective units.

Tables are always assigned to an application. The list can be sorted according to application.

There are two types of tables:

- METTLER TOLEDO tables:  
These tables are included in the factory settings, they are only listed and can be neither edited, viewed nor deleted.
- User-defined tables:  
Tables are laid out in the form of a value table (X-Y). They can be created, edited and deleted.

Below is a description of how to create your own tables.

In addition to the tables, you can also administer the auxiliary values in setup. The auxiliary values can thereby be used in formulas. By means of the method function "Auxiliary value", an auxiliary value from any desired formula can be assigned raw data or calculated results.

#### See also

- Results and Statistics (page 62)

## 5.5.1 Tables

**Navigation:** Home > Setup > Tables & values > Tables

By opening the **Tables** dialog you can see a list of available tables (METTLER TOLEDO and user-defined).

How to create tables in the setup is described below.

You can create a table with the **New** button.

| Parameters   | Description  | Displayed if |
|--------------|--|--------------|
| Name         | Table name: The name uniquely identifies the table in the system. The name is entered into the formula in the method function "Calculation".   | -            |
| Application  | Application area of table. Facilitates the sorting of the table list.  | -            |
| Input value  | Table heading for the input value.   | -            |
| Output value | Table heading for the output value.  | -            |
| Fit type     | Definition of the curve type for the calculation. <ul style="list-style-type: none"> <li>• Linear interpolation: Corresponds to a segmented curve.</li> <li>• Lagrange interpolation: Lagrange fit via four points</li> <li>• 1 order polynom</li> <li>• 2 order polynom</li> <li>• 3 order polynom</li> </ul> | -            |

1 Save the new table.

⇒ A dialog opens with the name of the new table.

2 Enter value pairs via **New**.

| Parameters     | Description  | Displayed if |
|----------------|--|--------------|
| "Input value"  | Input value of the value pair (corresponding to the measuring cell used, e.g. density or refractive index) | -            |
| "Output value" | Output value of the value pair (e.g. Brix)   | -            |

At least four value pairs must be entered and then saved via the **Save** button.

– Touch the button **Graph**. The fit function is graphically presented (the button **Graph** is only displayed if the table has been saved).

**Note:** The axis labeling corresponds to the specified "Input" – (x-axis) and "Output" parameters (y-axis).

⇒ The table has been successfully entered. The coefficients are calculated according to the selected function. There is a "delta" column that shows the deviation from the calculated value at the effective table point (only for the "Fit type" = "Polynomial"). This column is not shown when the table is being edited.



- In the **Table – parameters** dialog, you can again remove the table via the **Delete** button.
- A table must contain at least 4 and contain a maximum of 200 value pairs.
- A maximum of 30 user-defined tables may be defined.
- Tables cannot be deleted or modified when they are currently in use.
- The table name must be unique.

## 5.5.2 Auxiliary Values

**Navigation:** Home > Setup > Tables & Values> Auxiliary values

Via the **New** button, you open the **Auxiliary values parameters** dialog. In it you can use the following parameters to define the auxiliary value:

| Parameters                 | Description   | Displayed if                           |
|----------------------------|---|--|
| Name                       | Unique designation of the auxiliary value: The name is entered into the formula in the method function "Calculation". | -                                      |
| Comment                    | Short comment on the auxiliary value (e.g. about the unit)  | -                                      |
| Value                      | Numerical value   | -                                      |
| Determination method       | Type of determination method (info field)   | -                                      |
| Determination date         | Date on which determination was performed (info field)  | -                                      |
| Performed by               | Person who performed determination  | -                                      |
| Monitoring auxiliary value | Specifies whether the auxiliary value is to be monitored.   | -                                      |
| Interval                   | Specifies the time period for monitoring of the auxiliary value.  | "Monitoring auxiliary value" activated |
| Expiry date                | Expiry date of auxiliary value (info field)   | "Monitoring auxiliary value" activated |
| Reminder                   | Defines whether a reminder should be issued before expiry of the auxiliary value.                                     | "Monitoring auxiliary value" activated |
| Days before expiration     | Specifies the number of days after which a warning is triggered.  | "Reminder" activated                   |



- A maximum of 100 auxiliary values can be saved in the instrument.
- Auxiliary values cannot be deleted or modified when they are currently in use.
- When an auxiliary value is assigned with the "Auxiliary value" method function, this is updated in the setup immediately after completion of the method function.

## 5.6 Maintenance & Service

**Navigation:** Home > Setup > Maintenance & Service

The following functions are available to you:

- MT service
- Import / Export
- Add external cell
- Reset to factory settings
- Firmware
- Update
- Hardware / Firmware summary
- Cell
  - One-point temperature alignment (only for density - module)
  - Whole-range temperature alignment
  - Fan check
  - Add manual adjustment
- Export of adjustments / tests / measurements

### 5.6.1 MT Service

**Navigation:** Home > Setup > Maintenance & Service> MT Service

Via the button **MT Service** you can open the **Last MT services** dialog window.

In this dialog, you can view and print out a list of the most recent (max. 10) METTLER TOLEDO services. Under each date, the user name of the METTLER TOLEDO service technicians and the date and time of the service appointment are displayed. The most recently performed service always appears at the top of the list.

Via the **Settings** button in the **Last MT services** dialog window you can open the **Service data** dialog window, via which you can edit the service life of the last service due date. You can define whether a warning should be issued before the service life expires (requires administrator rights). You can define the following parameters:

- "Service life" (in days) of the most recently performed service.
- "Reminder": Defines whether a reminder should be issued before expiry of the service life of the service.
- "Days before expiration" Number of days before expiration of the service life on which the instrument should issue a warning.  
The entered value must be smaller than the value for the service life (only appears if "Reminder" has been activated).

## 5.6.2 Import / Export

**Navigation:** Home > Setup > Maintenance & Service> Import / Export

With the aid of this feature you can save the data on a UBS stick (export) or import data from a stick. The following can be imported or exported:

- Single method
- All methods
- Single product
- All products
- Single series
- All series
- Single table (only affects user-specific tables)
- All tables (only affects user-specific tables)
- User management
- Memory copy

The following rules apply for Import / Export:

1. Import/Export is only possible when a USB stick is connected.
  2. Import/Export is only possible when no task is running.
  3. Products can only be imported if referenced methods are already available on the device required for the import.
  4. Series can only be imported if referenced methods or products of the series are already available on the device required for the import.
- In the **Maintenance & Service** dialog, open the **Import / Export** dialog window. In this dialog, you can define the following parameters:
- ⇒ "Action": Data can be exported to a USB stick or imported back from a USB stick.
  - ⇒ "Data": Data that is to be exported or imported can be selected.

### Memory copy

You can create a memory copy from your data. This includes adjustment and test data, auxiliary values, short-cuts and fingerprints, data relating to automation, peripherals and external instruments. When a firmware upgrade of the instrument has to be done, the instrument can be restored from the memory copy. The memory copy can also be imported to another instrument. In this case, the Test and Adjustment history are not imported and an adjustment of the instrument is required.

Uploading data from a backup copy results in the existing data being overwritten by the data in the memory copy. In this way you can restore the initial status.





- **Not** contained in a memory copy are any saved results, default parameters for manual operations, internal tables, hardware for cell creation or parameters for added external cells.
- When you import / export user management settings the entire user management settings with all users and their properties are exported or imported.
- If the import is canceled, all previously imported users are deleted and only a default user (administrator) is created.
- You must have administrator rights before you can create and reimport a backup copy.

### 5.6.3 Add External Cell

**Navigation:** Home > Setup > Mainten. & Service > Add external cell

Perform the action "Add external cell". In the **Cell** dialog box, the cell type must be selected (Home > Setup > Hardware > Cell).

When you connect the external cell (module), the status changes to "installed" and the effective serial number is entered.

If the external cell is removed, the entry in the cell list is retained. The status changes to "not installed". The serial number and the cell type however continue to be displayed.

### 5.6.4 Reset to Factory Settings

**Navigation:** Home > Setup > Maintenance & Service > Reset to factory settings

With the button **Reset to factory settings** you can reset your settings.



If you do this all created data, amendments, settings, setup entries or results are lost. Before you activate "Reset to factory settings" you should create a memory copy.

### 5.6.5 Firmware

**Navigation:** Home > Setup > Maintenance & Service > Firmware

With the aid of this feature you can display a list showing the most recent firmware updates. The first entry in the list corresponds to initial operation.

All list entries are saved with a date and FW version.

### 5.6.6 Update

**Navigation:** Home > Setup > Maintenance & Service > Update

With the aid of this feature a firmware update of the instrument, device board and cells can be performed via a USB stick. After the button **update** is touched, all available and associated components that contain firmware are presented in a list (Instrument FW, cell FW, Device Board FW).

- ▶ You must have administrator access rights.
  - The instrument is in idle mode (no task is active).
  - To update a cell, the cell must be connected. In the process each update must be performed separately for each connected cell that is to be updated.
- 1 Via the button **update** you can open the **Firmware – List** dialog. Select the relevant components from this list.
- 2 Plug in the USB stick with the firmware update files into the instrument.
  - ⇒ The instrument recognizes the USB stick and enables the update.
- 3 Start the update.
  - ⇒ The instrument reboots and starts the update program via the USB stick. The update can be performed in the update program.
- 4 When the update program is terminated, the instrument reboots with the normal application.

**Instrument update:**

All results, settings, setup entries, methods, products and individual modifications are lost during the instrument firmware update. On the other hand, the service history, the instrument firmware history and serial number are all retained.

**Cell update:**

- Only updates from connected and recognized cells are offered, whose update file is on the USB stick.
- With the cell update, no changes are made to the application program and to the individual settings and methods.

**Device board update:**

With the device board update, no changes are made to the application program and to the individual settings and methods.

### 5.6.7 Hardware / Firmware summary

**Navigation:** Home > Setup > Maintenance & Service > Hardware / Firmware summary

You can view a list with all connected components along with the corresponding information on hardware or firmware. The list can be saved as a file on a USB stick. The file name contains the serial number of the device and the current date and time. Example:

HW\_SW\_Info\_5124560983\_23\_03\_2010\_08\_23.cvs

### 5.6.8 Board Tests

**Navigation:** Home > Setup > Maintenance & Service > Board tests

With this function, the interfaces of various boards can be tested:

- Main board
- Device board
- External cell board, if an external cell is connected

The sequence for testing the boards is described below:

- 1 Via the button **Board tests** you can open the **Boards** dialog. In this dialog, buttons are provided, which guide you to the corresponding board information for the connections.
- 2 Touch the button for the desired board and you will receive an information list with the connections on the board and the required resources that must be plugged into the corresponding connection.
- 3 Touch the **Start** button, to go to the list of test functions.
  - By touching a test, you change over to the corresponding test and this can then be started. Pop-ups guide you through the test process and show you any errors identified.
  - The test result is also displayed in the interface list.
- 4 You can select another interface and proceed as described above or you can cancel the test with the **Stop** button.
  - ⇒ When all interfaces for the selected board have been tested and all have the status "successfully passed", the results can be written onto the USB stick.

### 5.6.9 Cell

**Navigation:** Home > Setup > Maintenance & Service > Cell

Via the **Cell** you get to the service function of the cells.

This dialog window contains the following buttons:

| Button                          | Parameters   |
|---------------------------------|--|
| One-point temperature alignment | Adjustment of the cell temperature to the set temperature. The block thermistor is adjusted to the certified cell thermistor at the current set temperature.<br><br>The <b>One-point temperature alignment</b> dialog shows the selected cell, the set (Tset), the cell (Tcell) and the cell block temperature (Tblock). |

| Button  | Parameters   |
|---|--|
| Whole-range temperature alignment   | Adjustment of the cell temperature to the set temperature across the entire temperature range.<br><b>Note:</b> The alignment takes about two hours.  |
| <p>The <b>Whole range temperature alignment</b> dialog shows the selected cell, the current values of the set (Tset), cell (Tcell), cell block- (Tblock) and the ambient temperature (Tambient).</p> <p>The alignment can be started when the temperature in the cell is stable and the cell is dry and clean.</p> <p><b>Note:</b></p> <ul style="list-style-type: none"> <li>• If there is an error message, the current values are saved on the display so that it can be seen at which temperature the error occurred.</li> <li>• With <b>Stop</b> the alignment can be interrupted at any time.</li> <li>• During alignment, the temperature per interval is saved in a file. This file can be saved on the USB stick.</li> </ul> |  |
| Fan check   | The functional efficiency of the fans is tested. The display is periodically updated.<br><b>Note:</b> The instrument is not switched off when there is an error display.                                     |
| Add manual adjustment   | This function simulates an adjustment. It is used in order to perform a measurement without previously adjusting the instrument.<br><b>Note: Only use for demonstration or method development processes!</b> |

### 5.6.10 Export Adjustments / Tests / Measurements

**Navigation:** Home > Setup > Maintenance & Service > Export of adjustments / Tests / Measurements

With the aid of this function, the adjustment, test and measurement history can be saved on the USB stick so that it can then be imported into an EXCEL file.

- The histories can be viewed and exported.
- The measurement history is only exported if the measured data agree with the current cell configuration (if the external cell type is changed, the measured data cannot be exported from the previous cell).

## 6 Methods and Products

Before you can perform a measurement you need a **method**. A method is an analysis program and consists of a sequence of method functions (some with method subfunctions), which are processed by the instrument in sequence.

Products are always linked to a method, and multiple products can be linked to the same method. It is therefore possible to work with only a few methods.

Using the **Print** button, you can generate a PDF file containing the methods or product parameters and product calculations.

**i** The **Print** button is active only when a USB stick is connected.

How to create methods and products, how to access them and apply them is described below.

### 6.1 Methods

A method basically consists of the configuration, sample feed, the actual measurement, cleaning, result calculation and the creation of a report. These steps are defined as functions. The individual functions in turn consist of parameters, whose values or names can be changed.

#### Method types

The instrument distinguishes between the following method types with different objectives:

- MS (Measurement), for the performance of a measurement
- ADJ (Adjustment), for an adjustment of the measuring cell(s)
- TE (Test), for testing the measuring cell(s)
- CL (Cleaning), for cleaning the measuring cell(s)

#### 6.1.1 Establishing Methods

When creating methods (max. number of methods: 30) you can make use of method templates with predefined method types and hence structures. The corresponding parameters thereby contain suitable default values.

Select: Home > Methods / Products > Methods

- 1 Choose **New** to create a new method on the basis of a template.
- 2 Select the desired method type from the available templates. Now you can adjust this method to your own specifications by adding or deleting method functions, or by adjusting the settings.
  - ⇒ After a template has been chosen, the **Configuration** dialog opens. Here, according to the defined setup, you can select the cell mode, the cell, automation unit and the external devices (pH, conductivity and colorimeter) with which you wish to carry out the method.

| Parameters   | Description  | Displayed if                  |
|--------------|--|-------------------------------|
| Cell mode    | Defines the cell(s)  | -                             |
| Automation   | Defines the automation unit used by the method. The choice available depends on the automation units defined in Home > Setup > Hardware > Automation.<br><b>Note</b> <ul style="list-style-type: none"> <li>• If the filling and rinsing is performed with "FillPal" and drying with "DryPal", then "FillPal+DryPal" must be selected.</li> <li>• If the InMotion autosampler is used together with a DryPal in method type "Clean", both (InMotion and DryPal) must be selected.</li> </ul> | -                             |
| Lid handling | Defines whether CoverUp (optional lid handling system on InMotion) is used in the method.  | Automation unit" = "InMotion" |

|              |   |  |
|--------------|---|--|
| pH           | Defines whether the pH meter is used in the method.           | "Method type" = "Measurement"<br>pH meter is defined in "Home > Setup > Hardware > External instruments".          |
| Conductivity | Defines whether the conductivity meter is used in the method. | "Method type" = "Measurement"<br>Conductivity meter is defined in "Home > Setup > Hardware > External instruments" |
| Color        | Defines whether the colorimeter is used in the method.        | "Method type" = "Measurement"<br>Colorimeter is defined in "Home > Setup > Hardware > External instruments".       |

**i** Up to the automation unit, these settings cannot be retrospectively modified.

|                               |  |  |
|-------------------------------|--|--|
| Color settings (Minolta only) | Activates "Illuminant" so that the illuminant type can be defined and "Observer" so that the angle can be entered. | -  |
| Illuminant                    | The following illuminants can be selected:<br>A, C, D65, D50, ID65, ID50, F2 to F12                                | "Color settings" (Minolta only)" activated |
| Observer                      | Viewing angle:<br>2°C or 10°C; default 2°C   | "Color settings" (Minolta only)" activated |

**i** The parameters "Color settings" (Minolta only), "Illuminant" and "Observer" are used only with Minolta colorimeters.

- 1 Confirm with **OK**.
- 2 In the "Title" method function, enter a new method ID. Afterwards, the new method will be stored under this method ID.
- 3 Save the method.
  - ⇒ You have now created a new method with its own ID. This method already has predefined method functions. To change the method functions proceed as follows:
- 4 Select available method functions to modify their parameters in line with your requirements.
- 5 Choose **Insert** to add additional method functions to the method.
- 6 Now use the arrow-shaped "Insert" button to select the required position for the new method function in the method. (You will only be able to insert the method functions that are allowed in the corresponding location based on the method syntax.)
  - Note:** It is a good idea to save at regular intervals.
- 7 From the list, select the method function that you want to insert.
- 8 Modify the individual parameters of the method function.
  - ⇒ The new method function will be displayed in the method.
- 9 To delete a method function, select the function in question and then choose **Delete**.
  - ⇒ The method function will disappear from the method.
    - Note:** Some essential method functions cannot be deleted. (The "Delete" button is not available in these cases.)
- 10 After inserting all desired method functions, you can store the new method in the device by choosing **Save**.

**i** When creating a new method, follow the rules specified by the device. These are described in Chapter "Method Syntax – Rules for Establishing methods".

## 6.1.2 Creating a Method Copy

You can copy an existing method by changing the ID of the method in the method function "Title". When the method is saved a new method is created.

## 6.1.3 Modifying or Deleting Methods

### Modifying a method

To modify a method, select: Home > Methods / Products > Methods

- 1 From the displayed list of methods, select the method that you want to modify.
- 2 As soon as the methods functions of the selected method appear on the screen, you can edit and save the method.

### Delete Method

It is simple to delete newly created methods. Select: Home > Methods.

- 1 Select the method that you want to delete.
- 2 Choose Delete method to delete the method from the memory.



Shortcuts, products and series that refer to the method will also be deleted.

## 6.1.4 Method Syntax

The following rules describe in which point method functions can be inserted or deleted. Only the available method functions are displayed for insertion.

### Rules for method type "Measurement" (MS)







- The following method functions cannot be deleted: Title, configuration, sample, filling, measure and online display.
- The method functions "Calculation" (R1, R2, ..., Rx) and "Temperature compensation" (TC1, TC2, ..., TCx) are indexed.
- A maximum of 20 method functions "Calculation" can be inserted.  
The method function "Temperature compensation" can be inserted a maximum of five times, in each case immediately after the method function "Measure".  
Insertion of the "Report" method function is limited for the following method types:
  - twice for "Measurement" and "Test"
  - once for "Adjustment" and
  - "Report" cannot be inserted for "Cleaning".

Method functions can be inserted in the method as follows:

### Rules for method type "Adjustment" (ADJ)

- The following method functions cannot be deleted: Title, Configuration, sample, Filling, Measuring and adjustment.
- The method functions are executed twice between "Sample" and "Adjustment".







The following method functions can be inserted in the method template:



| Template      | Method function   |
|---------------|---|
| Title         |   |
|               |  Instruction, Auxiliary instrument   |
| Configuration |   |
|               |  Instruction, Auxiliary instrument   |
| Sample        |   |
|               |  Clean, Instruction, Auxiliary value, Wait, Auxiliary instrument, Line rinse   |
| Fill          |   |
|               |  Instruction, Auxiliary value, Instruction, Wait, Auxiliary instrument         |
| Measure       |   |
|               |  Clean, Instruction, Auxiliary value, Wait, Auxiliary instrument, Line rinse   |
| Clean         |   |
|               |  Clean, Instruction, Auxiliary value, Wait, Auxiliary instrument, Line rinse |
| Adjustment    |   |
|               |  Instruction, Auxiliary instrument   |
| Report        |   |

### Rules for method type "Test" (TE)

The following method functions cannot be deleted: Title, Configuration, Sample, Filling, Measure and Test.

The following method functions can be inserted in the method template:

| Template      | Method function  |
|---------------|--|
| Title         |  |
|               |  Instruction, Auxiliary instrument  |
| Configuration |  |
|               |  Instruction, Auxiliary instrument  |
| Sample        |  |
|               |  Clean, Instruction, Auxiliary value, Wait, Auxiliary instrument, Line rinse                      |
| Fill          |  |
|               |  Instruction, Auxiliary value, Wait, Auxiliary instrument   |
| Measure       |  |
|               |  Report, Clean, Instruction, Auxiliary value, Wait, Auxiliary instrument, PowerShower, Line rinse |
| Clean         |  |
|               |  Clean, Instruction, Auxiliary value, Wait, Auxiliary instrument                                  |
| Test          |  |

-  Report, Clean, Instruction, Auxiliary value, Wait, Auxiliary instrument, PowerShower, Line rinse
- Clean
-  Report, Clean, Instruction, Auxiliary value, Wait, Auxiliary instrument, PowerShower, Line rinse
- Report
-  Report, Clean, Instruction, Auxiliary value, Wait, Auxiliary instrument, PowerShower, Line rinse



**i** The "Report" method function can be inserted a maximum of two times. There is no limit on the other method functions.

**Rules for method type "Clean" (CL)**

The following method functions cannot be deleted: Title and Configuration.

For the method type "Clean" at least a method function "Clean" or "Cell test" must be available.

The following method functions can be inserted in the method template:

| Template      | Method function   |
|---------------|---|
| Title         |  Instruction, Auxiliary instrument   |
| Configuration |  Clean, Instruction, Wait, Auxiliary instrument, Stir, Park, PowerShower, Line rinse |
| Clean         |  Clean, Instruction, Wait, Auxiliary instrument, Stir, Park, PowerShower, Line rinse |

**6.1.5 Standard Data**

The standard data are editable according to mode and standard.

| Parameters         | Description  | Displayed if     |
|--------------------|--|------------------|
| Standard name      | Description of the standards                               | -                |
| Lot number         | Lot number / batch number of the standard                  | Standard not air |
| Certification date | Certification date of the standard                         | Standard not air |
| Expiry date Std    | Expiry date of the standard                                | Standard not air |
| nD nominal         | Nominal refractive index value of standard                 | Cell = R         |
| d nominal          | Nominal density of standard                                | Cell = D         |
| Uncertainty        | Limits of error of standard – belongs to the nominal value | Standard not air |

**6.1.6 Condition**

A logical condition can be defined to determine whether a particular method function should be executed based on a result (true or false). The condition is in the format of a formula. An empty condition is interpreted as true.

Formulas can be used in various method functions. In formulas you can enter the calculated results Rx, temperature-compensated values (TCx), tables, auxiliary values and raw data.

**Formula Editor**

**Navigation:** Home > Methods / Products > Methods > Method > Calculation

With the formula editor both numerical values and symbols can be entered. The symbols **H**, **T** and **C** are made available when you select the **1** button in the formula editor.

If you touch **H**, the list of auxiliary values opens; **T** opens the table list; **C** opens the list of color scales for the colorimeters. For colorimeters, it is possible to define whether measurements should be carried out in extinction or transmission mode.

You can enter raw data manually or via insert via the button "Proposal". You will find the raw data in the "Annex: Raw data".



## Mathematical Functions and Operators

The following mathematical functions and operators can be used in formulas:

| Functions                |                              | Comparison operators     |               |
|--------------------------|------------------------------|--------------------------|---------------|
| Logarithm to the base 10 | lg(x)                        | equal to                 | =             |
| Logarithm to the base e  | Ln(x)                        | larger than              | >             |
| Exponential to base 10   | pw(x) or scientific notation | larger than or equal to  | > =           |
| Exponential to base e    | ex(x)                        | smaller than             | <             |
| Square                   | sq(x)                        | smaller than or equal to | <=            |
| Square root              | sr(x)                        | x in the range of        | ... < x < ... |
|                          |                              | not equal to             | < >           |
| Mathematical operators   |                              | Logical operators        |               |
| Addition                 | +                            | and                      | AND           |
| Subtraction              | -                            | or                       | OR            |
| Multiplication           | *                            |                          |               |
| Division                 | /                            |                          |               |



- Logical operators are only permitted within formulas of the subfunction "Condition".
- The use of mathematical operators (+, -, \* and /) within a parenthetical expression is not possible.

### Formula Syntax

#### - Brackets

There are three types of brackets that can be used in formulas:

- Round brackets "( )":  
e.g. T[Table\_name(d)] and mathematical operators ln(d)
- Square brackets "[ ]"  
- Table name T[Table\_name()], e.g. T[Brix\_d\_NBS(d)];  
- Auxiliary value H[Auxiliary\_value], e.g. H[Auxiliary\_Value\_1]
- Curly brackets "{ }": Relation to the cell, e.g. d[DX]. If the cell is not specified, then the internal cell is used as default.

#### - Fixed abbreviations

The following abbreviations are defined:

|                  |  |
|------------------|--|
| RM               | Internal refractive index cell   |
| DX               | Density - module   |
| RX               | Refractive index module  |
| R1 ... Rx        | Results from the method function "Calculation"                               |
| TC1 ... TCx      | Results from the method function "temperature compensation"                  |
| A, B, C, D, x, y | Coefficients (A-D) and variables (x,y) can be used in formulas, e.g. Ax + B. |

#### - Syntax examples

- Simple raw result: R1 = nD
- Temperature compensation: R1 = TC1
- Tables: R1 = T[Brix\_nD\_20C (nD)]

The following values can be entered for tables:

- Internal tables: d, dRaw, TC
- User-defined tables: All generated analysis data
- Density modules: d, dRaw, TC
- Internal refractive index cell: nD, TC

### 6.1.7 Method Function

All method functions for the instrument are listed below:

### 6.1.7.1 Title

The method function "Title" contains general method data.

| Parameters  | Description   | Displayed if    |
|-------------|---|-----------------|
| Type        | Method type (measurement, adjustment, test, cleaning): Defined by the selection of the method template during creation of the method (info field).  | -               |
| Method ID   | The method is uniquely identified in the system via the method ID. Once the method has been saved, the method ID can no longer be changed. A change of the method ID results in the creation of a copy of the method. | -               |
| Title       | Title of the method.  | -               |
| Author      | Name of creator (info field)  | -               |
| Created on  | Date of creation and time (info field)  | -               |
| Modified at | Change date and time (info field)   | -               |
| Modified by | User who made change (info field)   | -               |
| Protect     | When this is activated, only the author or an administrator can edit or delete the method.  | -               |
| SOP         | On activation a text is displayed before the start.   | -               |
| SOP-Text    | Displayed SOP text  | "SOP" activated |

### 6.1.7.2 Configuration

Used for making settings for cells, automation and external instruments.

The settings in the method function "Configuration" affect the parameters of the following method functions.

| Parameters                    | Description  | Displayed if                               |
|-------------------------------|--|--|
| Cell mode                     | Display of cells to be used in the method (info field)   | -  |
| Automation                    | Defines the automation unit used by the method. The choice available depends on the automation units defined in Home > Setup > Hardware > Automation.<br><b>Note</b> <ul style="list-style-type: none"> <li>If the filling and rinsing is performed with "FillPal" and drying with "DryPal", then "FillPal+DryPal" must be selected.</li> <li>If the InMotion autosampler is used together with a DryPal in method type "Clean", both (InMotion and DryPal) must be selected.</li> </ul> | -  |
| Lid handling                  | Defines whether CoverUp (optional lid handling system on InMotion) is used in the method.  | Automation unit" = "InMotion"              |
| External instruments          | Display of external instruments (pH, conductivity, color) to be used in the method is to be measured (info field)  | -  |
| Color settings (Minolta only) | Activates "Illuminant" so that the illuminant type can be defined and "Observer" so that the angle can be entered.   | -  |
| Illuminant                    | The following illuminants can be selected:<br>A, C, D65, D50, ID65, ID50, F2 to F12  | "Color settings" (Minolta only)" activated |
| Observer                      | Viewing angle:<br>2°C or 10°C; default 2°C   | "Color settings" (Minolta only)" activated |

**i** The parameters "Color settings" (Minolta only), "Illuminant" and "Observer" are used only with Minolta colorimeters.

### 6.1.7.3 Sample

By means of the method function "Sample", sample data for the following method types are defined:

#### Method type: Measurement

| Parameters           | Description                            | Displayed if             |
|----------------------|--|--------------------------|
| Viscosity correction | Activation of the viscosity correction | Density - Module defined |

|                   |   |   |
|-------------------|---|---|
| Viscosity         | <p>≤2000:<br/>For samples with viscosity less than 2000 mPa*s</p> <p>&gt;2000:<br/>For samples with viscosity greater than 2000 mPa*s</p> <p>- Set value:<br/>With this selection, a known viscosity can be entered</p> | <p>Density - Module connected</p> <p>Viscosity correction activated</p> |
| Viscosity Value   | Viscosity of the sample   | "Viscosity" = "Set value"   |
| Sample ID         | Sample ID can be entered; you can still change this ID at the analysis start.   | "Method type" = "Measurement"   |
| Correction factor | This factor (f) can be included in the calculations. It can be changed before performance of the analysis in the <b>Start analysis</b> dialog.  | -   |
| Comment           | <p>A comment was entered before performance of the analysis in the <b>Start analysis</b> dialog.</p> <p>Method type "Adjustment" / "Test" = The standards will be shown additionally.</p>                               | -   |

#### Method type: Adjustment

| Parameters           | Description   | Displayed if  |
|----------------------|---|---|
| Viscosity correction | Activation of the viscosity correction  | Density - Module defined  |
| Viscosity            | ≤2000 (info field)  | <p>Density - Module defined</p> <p>Viscosity correction activated</p> |
| Adjustment mode      | <p>Controls the selection of the adjustment sets and the standard specific data. The selection is filtered according to the modes of the available sets in the <i>Method &gt; Setup &gt; Adjustment sets</i>. The following adjustment modes are available:</p> <ul style="list-style-type: none"> <li>- Air&amp;Water (recommend settings)</li> <li>- Air&amp;Standard (only for density - module)</li> <li>- Water&amp;Standard (only for density - module)</li> <li>- Standards</li> </ul> | -   |
| Adjustment set       | <p>The adjustment set defines the standards and the temperature at which the adjustment is performed. With Air&amp;Water the instrument accesses its internally saved nominal value tables, with Standard the nominal value must be entered by the user. The selection of the sets is filtered via the adjustment mode. The adjustment set must be entered for each cell.</p>   | -   |
| Adj. temperature     | The adjustment temperature is displayed (info field).   | -   |
| Standard 1 ... 2     | Shows the parameters of the standard  | -   |
| Comment              | <p>A comment was entered before performance of the analysis in the <b>Start analysis</b> dialog.</p> <p>Method type "Adjustment" / "Test" = The standards will be shown additionally.</p>   | -   |

**i**

**Please note:** For using an **adjustment set** "Standards" in an RM/RX, a valid adjustment based on Air&Water must be stored in the instrument for the same temperature.

#### Method type: Test

| Parameters           | Description   | Displayed if  |
|----------------------|---|---|
| Viscosity correction | Activation of the viscosity correction  | Density - Module defined  |
| Viscosity            | <p>≤2000:<br/>For samples with viscosity less than 2000 mPa*s</p> <p>&gt;2000:<br/>For samples with viscosity higher than 2000 mPa*s.</p> | <p>Density module specified and</p> <p>viscosity correction activated</p> |

|                  |   |   |
|------------------|---|---|
| Test mode        | Controls the selection of the test sets and the standard specific data. The selection is filtered according to the modes of the available sets in the <code>Home &gt; Setup &gt; Test sets</code> . The following test modes are available:<br>- Air (Internal standard value table) (only for density - module)<br>- Water (internal standard value table)<br>- Default<br>- Brix standard | - |
| Test set         | The test set defines the standards and the temperature at which the test is performed. The selection of the sets is filtered via the test mode.<br>The test set must be entered for each cell.  | - |
| Test temperature | The test temperature is displayed (info field).   | - |
| Standard         | Shows the parameters of the standard  | - |
| Comment          | A comment was entered before performance of the analysis in the <b>Start analysis</b> dialog.<br><br>Method type "Adjustment" / "Test" = The standards will be shown additionally.  | - |

You can find detailed information on the standards in "Methods and products: Methods > Standard data (page 40)".

#### 6.1.7.4 Fill

Sample feed via the automation unit specified in the method function "Configuration".

| Parameters           | Description   | Displayed if  |
|----------------------|---|---|
| Prompt for sample    | When activated a confirmation appears on completion of the method function "Fill", stating that the task is interrupted until confirmed.  | -   |
| Speed                | <b>Pump speed</b><br>"SC1" / "SC30":<br><ul style="list-style-type: none"> <li>"Maximum": Sample feed with maximum pump speed</li> <li>"Reduced": Sample feed with speed set at the automation unit</li> <li>"Automatic": The pump speed changes according to the defined time period from "Reduced" to "Maximum".</li> </ul> "FillPal" / "InMotion":<br><ul style="list-style-type: none"> <li>"High"</li> <li>"Medium"</li> <li>"Low"</li> </ul> The corresponding pump speed can be set under <code>Home &gt; Setup &gt; Hardware &gt; Automation</code> . | "Automation" =<br>"FillPal" / "SC1" /<br>"SC30" / "InMotion"  |
| Max. speed after [s] | The pump switches over to the maximum speed after this time   | "Automation" = "SC1" /<br>"SC30"<br><br>"Speed" = "Automatic"   |
| Filling mode         | Defines the way in which the sample feed is to be stopped.<br>"Fixed duration": The sample feed is stopped after a certain time.<br>"Automatic": The measuring signal is used to detect when the sample fluid has reached the measuring cell (not for "InMotion")   | "Automation" =<br>"FillPal" / "SC1" /<br>"SC30" / "InMotion"  |
| Fill time            | Filling time in [s]   | "Automation" =<br>"FillPal" / "SC1" /<br>"SC30" / "InMotion"<br><br>"Filling mode" = "Fixed duration" |
| Fill ratio           | Defines the percentage by which the cell is "overfilled". For example: After 10 s pumping, the sample is recognized in the cell, the fill ratio is 150%, i.e. the pump switches off after 15s (feed duration + feed duration x ("fill rate" - 100) / 100).  | "Automation" = "FillPal" /<br>"SC1" / "SC30"<br><br>"Filling mode" = "Automatic"                      |

|                     |  |   |
|---------------------|--|---|
| Sample detection at | Selection of cell at which the sample detection is performed.  | "Automation" = "FillPal" / "SC1" / "SC30"<br><br>"Filling mode" = "Automatic";<br>2-cell method |
| Max. fill duration  | Sample feed is stopped at the latest after this time, if no new sample is detected in the cell.<br><br>The task is continued to completion, however the method functions "Fill" and "Measure" are skipped. | "Automation" = "FillPal" / "SC1" / "SC30"<br><br>"Filling mode" = "Automatic"                   |
| Pressure release    | Defines if the pressure shall be released after filling the cell(s).   | "Automation" = "SC1" / "SC30"   |

### 6.1.7.5 Measure

Via the method function "Measure", the measurement, data capture and error detection can be configured. It contains the following subfunctions that are described below:

"Cell"

"Measured value acquisition"

"Error detection"

#### Subfunction Cell – method type: Measurement

| Parameters              | Description   | Displayed if                 |
|-------------------------|---|------------------------------|
| Measurement temperature | Input of meas. temperature; the temperature can be defined per cell.  | -                            |
| Adjustment set          | Defines which adjustment set is used.   | -                            |
| Action when expired     | This parameter defines the behavior if an adjustment set expired.<br>In <code>Home &gt; Setup &gt; Cell</code> the monitoring of the adjustment set can be set.<br>Action:<br><ul style="list-style-type: none"> <li>• "Block": The method is no longer executable.</li> <li>• "Warn": A message is shown at the method start. In spite of this, the method is performed. The analysis is labeled with the status "OK*".</li> <li>• "None": No action</li> </ul>                                  | -                            |
| Adj. temperature        | The adjustment temperature is displayed (info field).   | -                            |
| Verify test set         | Defines that a method can be executed for the valid test set (the last test was passed with the corresponding test set).  | -                            |
| Test set                | Selection of test set to be verified  | "Verify test set" activated  |
| Action                  | This parameter defines the behavior with an expired test set and whether the last test was valid or not.<br>(in <code>Home &gt; Setup &gt; Cell</code> it is possible to configure monitoring of the test set):<br><ul style="list-style-type: none"> <li>• "Block": The method can no longer be run.</li> <li>• "Warn": A notification is displayed when the method is started. The method is still executed despite this notification. The analysis is tagged with the status "OK*".</li> </ul> | "Verify test set" is enabled |

#### Subfunction cell – method type: Adjustment

| Parameters       | Description   | Displayed if |
|------------------|---|--------------|
| Adj. temperature | The adjustment temperature is displayed (info field). | -            |

#### Subfunction cell – method type: Test

| Parameters       | Description                                     | Displayed if |
|------------------|---|--------------|
| Test temperature | The test temperature is displayed (info field). | -            |
| Adjustment set   | Defines which adjustment set is used.           | -            |

|                     |  |   |
|---------------------|--|---|
| Action when expired | This parameter defines the behavior if an adjustment set expired. In Home > Setup > Cell the monitoring of the adjustment set can be set.<br>Action:<br><ul style="list-style-type: none"> <li>• "Block": The method is no longer executable.</li> <li>• "Warn": A message is shown at the method start. In spite of this, the method is performed. The analysis is labeled with the status "OK*".</li> <li>• "None": No action</li> </ul> | - |
| Adj. temperature    | The adjustment temperature is displayed (info field).  | - |

#### Subfunction measurement acquisition – method types: Measurement, adjustment and test

| Parameters          | Description   | Displayed if   |
|---------------------|---|--|
| Wait time R         | The refraction index measurement begins after this time has elapsed. This wait time ensures that the prism is completely wetted with liquid. In the case of multiple measurements, each measurement is started after this wait time has elapsed.  | -  |
| Wait time Col       | The colorimetric measurement begins after this time has elapsed. In the case of multiple measurements, only the first measurement is started after this wait time has elapsed. All other measurements begin with no wait time.  | External instrument = Colorimeter ("Configuration" method template: "Color" activated) |
| End point           | <b>Fixed duration:</b><br>The measurement is stopped after a certain time. This function is used to shorten the measurement time if high precision is not required. The measurement is stopped on achievement of the maximum measurement reliability at the latest.<br><b>Automatic:</b><br>The measurement is ended if the defined stability criteria have been achieved.<br>(For the method types "Adjustment" and "Test" the "End point" = "Automatic" (info field)) | -  |
| Meas. duration      | Duration of measurement in [s]  | "End point" = "Fixed duration"   |
| Meas. reliability   | Setting of stability criteria for meas. value acquisition.<br><ul style="list-style-type: none"> <li>- Maximum: Highest reliability of measured</li> <li>- High</li> <li>- Medium</li> <li>- Minimum: Fastest measurement</li> </ul>  | "End point" = "Automatic"  |
| Max. meas. duration | Maximum duration of measurement. If the measured value has not stabilized by this time, the measurement will be canceled with the status "Error". (depending on the stability criteria of the parameter "Meas. reliability").   | "End point" = "Automatic"  |

You record the following measuring errors with the bubble check or a multiple measurement:

- air bubbles in the measuring cell (Bubble Check)
- Solvent residues in the measuring cell
- Solid particles in the sample

With the **Bubble Check** variations in the measuring signal are analyzed.

With **Multiple measurement**, n measurements are performed. Between measurements, the sample is subject to continual movement. The standard deviation of the n measurements is added, and checked to see whether it is smaller than the maximum standard deviation (Max. SD) defined in the method.

| Parameters           | Description  | Displayed if                     |
|----------------------|--|----------------------------------|
| Bubble Check         | When this is activated, the system checks whether any bubbles are present in the cell. | -                                |
| Multiple measurement | On activation several measurements are performed on the same sample                    | -                                |
| No. of measurements  | Input of number of measurements  | "Multiple measurement" activated |

|              |  |  |
|--------------|--|--|
| Refill ratio | Measurement for further movement of the sample between two measurements. The refill ratio is calculated using the duration of the sample addition. For example: The addition duration is 10 s and the refill ratio is 50%, i.e. pumping continues for 5 seconds.   | "Automation" =<br>"FillPal" / "SC1" /<br>"SC30" / "InMotion"<br><br>"Repeat if failed" activated<br><br>"Multiple measurement" activated |
| Max. SD      | Maximum permitted absolute standard deviation of the measurements for density, refractive index or color. When the deviation is exceeded the measurement is interrupted with the status "Error".<br><br>The maximum standard deviation must be entered in the function of the measuring cell type. The default value in the method is provided for an R40 cell. This should be adjusted for an R50 cell, e.g. 0.00002. | Multiple measurement activated   |

**i** For the calculation of the standard deviation SD of the color results, the first color result in the formula of the "Calculation" method function with the smallest Rx index is used.  
If no color result is included in the calculation, "-" will be displayed for the standard deviation, i.e. SD is within Max. SD.

Single values (d1 to d10) are available as raw results and can be used in a calculation (i.e. for a 3-fold measurement all 3 single values can be reported).

|                  |   |   |
|------------------|---|---|
| Repeat if failed | If this is activated, the measurement is repeated if a bubble check has failed or if "Max. SD" or "Max. Deviation" are exceeded.<br><b>Note:</b> If "Multiple measurement" is activated, all measurements are repeated. | "Bubble Check" activated, or<br>"Multiple measurement" activated, or<br>External instrument defined (pH meter, conductivity meter, colorimeter) |
|------------------|---|---|

**i** For "Repeat if failed", no wait time is included.

|                     |  |  |
|---------------------|--|--|
| No. of meas. points | Defines the number of measured points used for determining the mean value.<br><b>Note:</b> If multiple measurement is activated, only the measured values from the last measurement repetition are used. | pH or conductivity meter defined in method |
| Max. deviation      | The max. permissible absolute deviation of the measured values for the pH or conductivity meter. If this value is exceeded, the measurement is interrupted with an "Error".                              | pH or conductivity meter defined in method |

#### Subfunction Error detection – method type: Adjustment / Test

If you are using a density - module, the following additional functions are available:

| Parameters   | Description  | Displayed if |
|--------------|--|--------------|
| Bubble Check | When this is activated, the system checks whether any bubbles are present in the cell. | -            |

#### 6.1.7.6 Calculation

A result can be defined by means of the method function "Calculation". For this purpose any desired formula with raw data, tables or other calculated results can be entered (see also "Formula syntax and tables" and "Results (page 62)"). Results are displayed on the online screen. They are saved after the final "Calculation" method function has completed.

Results receive an index Rx, by which they can be referenced in formulas of other method functions. The calculation number (Rx) is increased (from R1 to R20) when the "Calculation" method function is inserted, independently of the sequence of the method functions. By means of the button "Results proposals" you can select the predefined results with unit, coefficients and formulas. You will find the list of predefined results in the Annex.

| Parameters | Description                                     | Displayed if |
|------------|---|--------------|
| Name       | Name of the result generated in the calculation | -            |
| Unit       | Unit of result                                  | -            |
| Formula    | Formula input for the calculation.              | -            |

|                              |  |                           |
|------------------------------|--|---------------------------|
| Coefficients                 | Specifies the coefficients that can be used in the formula.<br><b>Note:</b> For powers to the base 10 the "e"-convention may be used (e.g. 1.2e-4 --> 0.00012).  | -                         |
| Variable x / Variable y      | Use of variables in the formula  | "Coefficients" activated  |
| A / B / C / D                | The coefficients that can be used in the formula   | "Coefficients" activated  |
| Decimal places               | Defines the number of decimal places in the calculated result.   | -                         |
| Result limits                | Limit values for going above and below a result  | -                         |
| Lower limit                  | Lower limit of the result  | "Result limits" activated |
| Upper limit                  | Upper limit of the result  | "Result limits" activated |
| Interrupt if limits exceeded | Defines that the measurement will be interrupted if the result is outside the limits. It then receives the status "Error".<br>If this parameter is not activated, the measurement continues even if the limit value is exceeded.<br>The analysis then receives the status "Limit exceeded" | "Result limits" activated |
| Statistics                   | For the calculation, rolling statistics are activated.   | -                         |
| Print statistics             | Defines whether the statistics should be printed out for each sample.  | "Statistics" activated    |
| Formula (Condition)          | Define a specific condition for calculation.   | "Condition" activated     |

#### See also

- Calculations in Products (page 59)

### 6.1.7.7 Clean

Cleaning the measuring cell by means of the automation unit specified in the method function "Configuration".

| Parameters      | Description   | Displayed if  |
|-----------------|---|---|
| Drain           | Draining the measuring cell   | -   |
| Drain Direction | Defines the valve setting for draining:<br>Waste: A waste bottle is drained.<br>Vial: It is drained into a vial.  | "Automation" = "SC1" / "SC30"<br><br>"Automation" = "FillPal" / "InMotion"<br>(only for drain direction: Waste)<br><br>"Drain" activated    |
| Drain Mode      | Fixed duration:<br>Draining is stopped after a defined time.<br>Auto:<br>The drain duration depends on the sample feed (total duration equals the time for which the pump was in operation during filling). | "Automation" = "InMotion" (only drain mode: Fixed duration)<br><br>"Drain" activated  |
| Drain duration  | Draining time in [s]  | "Drain mode" = "Fixed duration"   |
| Drain ratio     | Duration of draining (in percentage of filling duration)  | "Drain mode" = "Automatic"  |
| Rinse Cycle (1) | Activation of the cleaning cycle  | "Automation" = "Fillpal" / "SC1" / "SC30" / "InMotion"<br><br>"Automation" = "InMotion" (only method type "clean", 2 rinse cycles possible) |



|                     |   |  |
|---------------------|---|--|
| Solvent             | Automation unit SC1 / SC30: Selecting the solvent. The selection depends on the solvents entered in Home > Setup > Hardware > Automation<br>The solvents are listed in the list field along with the connection. The name of the solvent is displayed during method execution in the notification that prompts the rinse process.   | "Rinse cycle" activated  |
| Rinse Mode          | <b>"Fixed duration":</b><br>Rinsing is stopped after a defined rinse duration.<br><b>Automatic:</b><br>The rinse duration depends on the sample feed (Total duration is the time for which the pump was in operation for filling).  | "Automation" = "FillPal" / "SC1" / "SC30" / "InMotion"<br>"Automation" = "InMotion" (only rinse mode: Fixed duration)<br>"Rinse cycle 1" activated |
| Rinse duration      | Rinse time in [s]   | "Rinse mode" = "Fixed duration"  |
| Rinse rate          | Duration of rinsing as percentage of filling duration   | "Rinse mode" = "Automatic"   |
| Air addition        | To increase the efficiency of rinsing, air is mixed with the solvent. A higher air ratio causes a more turbulent flow, meaning more intensive cleaning and lower consumption of fluid.<br><br>If Power Purge Unit (PPU) is used and activated in the setup of "SC1" / "SC30", the parameter "normal" is not available (only "low" and "very low").  | "Automation" = "SC1" / "SC30"<br>"Rinse cycle" activated   |
| Rinse cycle 2       | Activation of 2nd rinsing cycle; for the description of the parameter, see parameter "Rinse cycle 1".   | Rinse cycle 1 activated  |
| Dry                 | Activation of drying  | -  |
| Dry mode            | Fixed duration:<br>Drying is stopped after a defined time<br>For the density - the "dry mode" can also be set to "Automatic":<br>Automatic:<br>Drying is interrupted, when the oscillation value becomes stable.  | Drying activated   |
| Dry duration        | Drying time in [s]  | "Dry mode" = "Fixed duration"  |
| Max. dry duration   | Maximum drying time:<br>If the oscillation value has not stabilized by the end of this period, drying is terminated.  | Density - Module defined<br>Dry mode = Automatic   |
| Interrupt if failed | If this parameter is activated, the measurement is given the status "Error", if with dry mode "automatic" the oscillation value has not stabilized within the defined "Max. dry duration". The task list is then interrupted. If the parameter has not been activated, the measurement proceeds as normal, even if drying failed.<br>This parameter is necessary, for example, for when execution of the "Drying" method function is associated with a condition. | "Dry mode" = "Automatic"   |
| Prompt for DryPal   | Choose if you want a prompt on the homescreen for connecting the DryPal to the aspiration tube for drying.  | "Automation" = "InMotion"<br>"Dry" activated   |
| Suppress prompts    | Choose if you want to suppress prompts on the homescreen for the cleaning process.  | "Automation" = "FillPal" / "FillPal&DryPal"  |
| Formula (Condition) | Define a specific condition for cleaning.   | "Automation" = "InMotion"<br>Only if "Condition" activated   |

### 6.1.7.8 Online Display

You can define the number of displayed results for the online screen (two or four). You can also specify where the results should be placed.

| Parameters  | Description   | Displayed if              |
|---|---|---------------------------|
| Displayed results                                 | The number of results on the online screen can be selected.           | -                         |
| Top / bottom                                      | Place at which the calculated results can be displayed on the screen. | "Displayed results" = "2" |
| Top left / Top right / Bottom left / Bottom right | Place at which the calculated results can be displayed on the screen. | "Displayed results" = "4" |

### 6.1.7.9 Report

This method function defines the type and scope of the data to be output for a report sent to network, a USB stick, printer (stripe printer or network printer) or via a USB-RS232 interface. The "Report" method function refers to all previous method functions. "Report" contains the following parameters:

| Parameters                    | Description   | Displayed if |
|-------------------------------|---|--------------|
| Export to USB stick           | Analysis data can be exported to a USB stick in a CSV or/and PDF format. Multiple measurements are arranged in succession in the same file.<br>Data export to the USB stick is only possible when the USB stick is available. This can be checked using the option "Verify USB stick availability" (Home>Setup>Global settings>Analysis and resources behavior).                          | -            |
| Export to network             | Analysis data can be exported to a network folder in a XML, CSV or/and PDF format. Multiple measurements are arranged in succession in the same file.<br>Data export to the network is only possible when the network connectivity is available. This can be checked using the option "Verify network storage availability" (Home>Setup>Global settings>Analysis and resources behavior). | -            |
| Print / USB-RS232 data export | Data are either sent to a USB compact printer, to a network printer or exported via the USB-RS232 interface. You can define the type of data transfer using the "Printer type" parameter in the Setup menu (Home>Setup>Hardware>Peripherals>Printer).   | -            |
| Print Mode                    | The following values are available: "Summary" or "User defined".<br>If "Summary" has been selected, a brief summary of the most important data is printed.<br>If "User defined" has been selected, you are presented with additional parameters enabling you to define which data should be printed.  | -            |



"Print Mode" applies only to printing on the printer. For USB-RS232 data export, a fixed data record is exported. For information on the scope and syntax of the data export, see "RS232 Interface Description"

The following parameters are displayed for "Print Mode"="User defined":

|                            |   |                               |
|----------------------------|---|-------------------------------|
| Method/Product information | Method information is printed or exported, e.g. method ID or product ID, method type. A complete method is not printed. | "Print Mode" = "User defined" |
| Calculated results         | The results from the "Calculation" method functions can be printed or exported.   | "Print Mode" = "User defined" |
| Data                       | The raw results produced during the determination and used in the calculations are printed or exported.                 | "Print Mode" = "User defined" |
| Sample information         | Information on the sample (e.g. sample ID, viscosity, standard name) can be printed or exported.                        | "Print Mode" = "User defined" |
| Resource information       | Information on the resource used (e.g. auxiliary value, adjustment set, cell type) can be printed or exported.          | "Print Mode" = "User defined" |

The "Condition" and "Formula" parameters can be found in "Methods and products: Methods: Conditions and formulas".

The "Report" method function can be inserted a maximum of two times per method for the method types "Measurement" and "Test" and only once for "Adjustment". See also the flow chart in "Methods and products: Methods: Method Syntax".

### 6.1.7.10 Cell Test

The cell test can only be performed for the density - module.

The cell test is used for testing the cell in respect of dryness and cleanness.

| Parameters          | Description   | Displayed if |
|---------------------|---|--------------|
| Tolerance           | Maximum permissible deviation of the measured air density from the theoretical value  | -            |
| Max. test duration  | Maximum duration of the cell test in [s]. If the measured value has not stabilized by this time, the cell test will be interrupted and counts as having been failed.  | -            |
| Interrupt if failed | If activated, the measurement receives the status "Error" if the cell test is failed. The task list is interrupted. If the parameter has not been activated, the measurement proceeds as normal, even if the cell test has been failed. | -            |

### 6.1.7.11 Temperature Compensation

Temperature compensation allows you to measure a sample at a temperature and then to output the measured value at another temperature. This temperature compensation is used in the following cases:

- The measured value must for example be stated at 15 °C, however the sample is too viscous at this temperature. Therefore these samples must be measured at correspondingly higher temperatures so that they can be pumped to the measuring cell and remain fluid there.
- For accelerated measurements. If the sample is delivered at 35 °C for example and the measured value is required at 15 °C, the sample can be measured at 35 °C and the measured value can be compensated to 15 °C.
- If the required reference temperature is outside the range of the measuring instrument (e.g. 120 °C), the sample can be measured at 75 °C and the result compensated to 120 °C.

To use the temperature compensation, the temperature dependence of the sample must be known.

If you have connected a density - module, you can also use the API table (ASTM-D 1250). The following tables are used (for crude oils, refined products, lubricants):

- 53A, 53B and 53D for **15 °C**
- 5A, 5B and 5D for **60 °F**
- 59A, 59B and 59D, for **20 °C**



The aforementioned ASTM or API tables take as input values the readings taken from a hydrometer, which do not however make allowance for the coefficient of expansion of the glass hydrometer. Therefore the measured density cannot be directly used as the input value for these tables.

The measured values are converted to the desired temperature. The output value (TC) of this method function can be used in the method function "Calculation".

| Parameters        | Description   | Displayed if  |
|-------------------|---|---|
| Compensation type | API (only for external density measuring cell):<br>Temperature compensation with API tables<br>Formula:<br>Temperature compensation by entering any desired formula | -   |
| API table         | Selection of the relevant API table: Crude oil, refined products, lubricants  | Density - Module defined<br>Compensation type = API |

|                      |  |                                 |
|----------------------|--|---------------------------------|
| Compensation - temp. | <b>Compensation type = API</b> (only for density - module)<br>You can choose from among three reference temperatures (15 °C, 60 °F, 20 °C). The temperature is entered as the input value in the algorithm for calculating the API compensation.<br><b>Compensation type = Formula</b><br>The defined value is for information purposes only and is not included in the calculation. | -                               |
| Output               | Selection of the unit in which the temperature compensated value is to be output.  | "Compensation type" = "API"     |
| Formula              | Input of a formula for temperature compensation.   | "Compensation type" = "Formula" |
| Coefficients         | Specifies the coefficients that can be used in the formula.<br><b>Note:</b> For powers to the base 10 the "e"-convention may be used (e.g. 1.2e-4 --> 0.00012).  | -                               |
| A / B / C / D        | The coefficients that can be used in the formula   | "Coefficients" activated        |

### 6.1.7.12 Adjustment

You can use the "Adjustment" method function to store the adjustment data in the setup for the corresponding cell(s). Here you can also perform an adjustment analysis that should be used to verify the accuracy of the determined adjustment data. In this process, the system checks the deviation from the last adjustment. If the maximum deviation is exceeded, you can decide at the end of the adjustment whether the data is transferred.

| Parameters          | Description                                 | Displayed if                    |
|---------------------|---|---------------------------------|
| Adjustment analysis | Evaluation of the adjustment                | -                               |
| Standard 1/2        | Shows the used standards (info field)       | "Adjustment analysis" activated |
| Max. deviation      | Input of the maximum permissible deviation. | "Adjustment analysis" activated |

### 6.1.7.13 Test

This method compares the measured with the theoretical test value. The data from the test is saved in the setup of the corresponding cell(s).

| Parameters     | Description                    | Displayed if |
|----------------|--------------------------------|--------------|
| Tolerance d/nD | Allowed tolerance for the test | -            |

### 6.1.7.14 Instruction

You can determine the output of a message to be displayed during the analysis process. The analysis is interrupted while the message is displayed.

| Parameters     | Description   | Displayed if                       |
|----------------|---|------------------------------------|
| Instruction    | Freely definable text. Via the input %x% reference can be made to results or raw data, e.g. %R1%.   | -                                  |
| Continue after | Confirmation:<br>The analysis is continued as soon as the message has been confirmed.<br>Time interval:<br>The analysis is continued at the latest after the defined time period has elapsed. | -                                  |
| Time interval  | Maximum time interval for the display of the instruction (early confirmation continues the analysis)  | "Continue after" = "Time interval" |
| Print          | The specified text is printed out from the printer.   | -                                  |

### 6.1.7.15 Auxiliary Value

By means of the method function "Auxiliary value" a result can be assigned an auxiliary value. These auxiliary values can be accessed in a formula (also in other methods).

| Parameters  | Description  | Displayed if       |
|-------------|--|--------------------|
| Name        | Selection of auxiliary value The selection relations to the list in the setup (Home > Setup > Tables & Values > Auxiliary values)                        | -                  |
| Formula H=  | Formula for the calculation of the auxiliary value.  | -                  |
| Limits      | By means of limits, the checking of the calculated value can be defined. If the value is outside the limits, it will not be saved as an auxiliary value. | -                  |
| Lower limit | Lower limit for the calculated value.  | "Limits" activated |
| Upper limit | Upper limit for the calculated values  | "Limits" activated |

### 6.1.7.16 Wait

By means of the method function "Wait" a method can be interrupted.

| Parameters | Description  | Displayed if |
|------------|--|--------------|
| Wait time  | Wait time before execution of next method function | -            |

### 6.1.7.17 Auxiliary instrument

This method function activates external auxiliary instruments and enables the instrument to communicate with these auxiliary instruments. Auxiliary instruments can be connected either to the "Aux" socket on the instrument board, the 24V output or to a USB interface by means of the USB-RS adapter (RS 232). The parameters described in the following apply to all control types. These are followed by parameters that can be defined explicitly for the relevant control type:

| Parameters   | Description  | Displayed if |
|--------------|--|--------------|
| Control type | Indicates which port on the measuring instrument is to be used for the auxiliary instrument.                   | -            |
| Name         | A name of your choice.   | -            |
| Condition    | Logical condition for defining whether or not a method function is executed based on a result (true or false). | -            |
| Formula      | Formula input for the calculation.   | -            |



A method function can be executed using a specified calculation formula (see also "Methods and products: Methods > Calculations and formulas").

#### Control type: 24V output

| Parameters | Description   | Displayed if   |
|------------|---|--|
| Mode       | Defines the mode for controlling the control output.<br>- Fixed duration: The control output is switched on for the defined time period.<br>- On   Off: The control outlet is switched on or off. After a sample series the control outlet is automatically switched off. | "Control type" = "Output 24 V"                               |
| Duration   | Here you can enter a time span, in [sec], for which the control output should be switched on.   | "Control type" = "Output 24 V",<br>"Mode" = "Fixed duration" |

#### Control type: USB-RS232

| Parameters              | Description  | Displayed if  |
|-------------------------|--|---|
| Send output sequence    | Determines whether an output sequence should be sent.  | "Control type" = "USB-RS232"                                      |
| Output sequence         | The control sequence for the signal receiver – can also contain a formula embedded in % characters, e.g. "%R1%" or "%d%" or ASCII control characters in the format \xxx. Here, xxx is the decimal code of the control character. | "Control type" = "USB-RS232" and "Send output sequence" activated |
| Wait for input sequence | The method function waits for a response sequence from the external device.  | "Control type" = "USB-RS232"                                      |

|                            |  |  |
|----------------------------|--|--|
| Maximum time               | The maximum waiting time for the input sequence, in [sec]. After it expires, the method is continued even if no sequence was received.   | "Control type" = "USB-RS232" and "Wait for input sequence" activated   |
| Input sequence             | The input sequence from the external device. The sequence can contain ASCII control characters in the format \xxx. Here, xxx is the decimal code of the control character.   | "Control type" = "USB-RS232" and "Wait for input sequence" activated   |
| Input sequence with result | Defines whether the input sequence of the external device contains results that should be imported.  | "Control type" = "USB-RS232" and "Wait for input sequence" activated   |
| Start sequence             | Start sequence of the incoming sequence from the external device. This is the reference position for the subsequent results. The start sequence can contain ASCII control characters in the format \xxx. Here, xxx is the decimal code of the control character. | "Control type" = "USB-RS232", "Wait for input sequence" activated and "Input sequence with result" activated |
| Total length               | Length from beginning of start sequence to end of final result. It is only after this length has been received that the results are extracted from the input sequence.   | "Control type" = "USB-RS232", "Wait for input sequence" activated and "Input sequence with result" activated |
| Number of results          | The number of results that should be extracted from the sequence from the external device.   | "Control type" = "USB-RS232", "Wait for input sequence" activated and "Input sequence with result" activated |
| Start position             | Start position (beginning) of the corresponding result; counted from the beginning of the start sequence. (Leading blanks before the result are ignored.)<br>Up to 10 results are supported.   | "Control type" = "USB-RS232", "Wait for input sequence" activated and "Input sequence with result" activated |
| Max. length                | Maximum length of the result; beginning at the start position of the result.   | "Control type" = "USB-RS232", "Wait for input sequence" activated and "Input sequence with result" activated |



- The ASCII control characters can be found at: <http://www.asciitable.com/>
- Results are stored under the variables "AuxInst x[y]" (x: result number; y: number of the "Auxiliary instrument" method function). For example: AuxInst 3[2]; where "3" represents the third result in the input sequence, which was received in the second auxiliary instrument method function in the method.

### 6.1.7.18 PowerShower

Rinsing with the defined number of rinse cycles in the setup.

| Parameters                   | Description   | Displayed if  |
|------------------------------|---|---|
| Beaker position              | Define the position of the rinse beaker.<br>Current position:<br>Rinsing is performed in the same beaker.<br>Next beaker:<br>Rinsing is performed in the beaker next to the tower (current position + 1).<br>Absolute position:<br>Rinsing is performed in a fix defined beaker on the sample rack. | "Automation" = "InMotion"   |
| Position (Beaker)            | Define the position of your rinse beaker on the sample rack.  | "Automation" = "InMotion"<br>Only if "Absolute position" is choosed   |
| Rinse cycles                 | Define the rinse cycles.  | "Automation" = "InMotion"<br>Only if "PowerShower rinse" is activated |
| Volume per cycle             | Define the solution volume which shall be used per rinse cycle.   | "Automation" = "InMotion"<br>Only if "PowerShower rinse" is activated |
| Volume (Fill beaker)         | Define the solution volume that shall be filled into the rinse beaker. The titration head will go into position "sample" for that.  | "Automation" = "InMotion"<br>Only if "Fill beaker" is activated       |
| Volume (Fill cell and tubes) | Define the solution volume that shall be filled into the measuring cell and into the tubes. The titration head will go into position "sample" for that.   | "Automation" = "InMotion"<br>Only if "Fill beaker" is activated       |
| Formula (Condition)          | Define a specific condition for rinsing with PowerShower.   | "Automation" = "InMotion"<br>Only if "Condition" is activated         |

### 6.1.7.19 Stir

With this method function you can define a fixed pre-stirring duration and also, if the stirrer shall be activated after the defined pre-stirring duration.

| Parameters        | Description  | Displayed if  |
|-------------------|--|---|
| Speed 1           | Define the stirrer speed in percent depending on the maximum speed of your stirrer (pre-stirring).   | "Automation" = "InMotion"   |
| Stir duration     | Define the stirring time for the pre-stirring. You can define two stirring sections (e.g. 10 s higher speeded for pre-stirring followed lower speeded until the end of measurement). | "Automation" = "InMotion"   |
| Continue stirring | Continued stirring after the defined stirring time in "Stir duration".   | "Automation" = "InMotion"   |
| Speed 2           | Define the stirrer speed after pre-stirring in percent depending on the maximum speed of your stirrer.   | "Automation" = "InMotion"<br>Only if "Continue stirring" is activated |

|                     |   |   |
|---------------------|---|---|
| Formula (Condition) | Define a specific condition for stirring. | "Automation" = "InMotion"<br>Only if "Condition" is activated |
|---------------------|---|---|

### 6.1.7.20 Line rinse

With this method function you can reach a better degree of cleanliness of the lines. For this a mixture between air and cleaning solution will be pumped through the lines, so the cleaning effect is much better than with cleaning solution only. The pump is running intermittently.

| Parameters          | Description  | Displayed if   |
|---------------------|--|--|
| Beaker position     | <p><b>Absolute position</b><br/>The system will move to the defined position on the turntable for the start of a sample.</p> <p><b>Current position</b><br/>The system will start looking for the first beaker to come.</p> <p><b>Next beaker</b><br/>The system will move to the beaker which is next to the tower (home position + 1). If no beaker can be detected, the sample changer moves to the next position (home position + 2) and repeats until a beaker is detected.</p> | "Automation" = "InMotion"<br>Only in method type "clean" |
| Duration            | Define the cleaning duration which depends on the length of the installed lines and on the wished degree of purity.  | "Automation" = "InMotion"                                |
| Descent rate        | Define the descent rate of the titration head during the rinse duration (very low, low, medium, high, very high).  | "Automation" = "InMotion"                                |
| Formula (Condition) | Define a specific condition for line rinse.  | "Automation" = "InMotion"<br>"Condition" is activated    |

### 6.1.7.21 Park

With this method function you can park the InMotion head in a beaker, e.g. parking the pH electrode in a beaker with buffer.

|                     |   |  |
|---------------------|---|--|
| Park position       | <p>Define the park position.</p> <p><b>Absolute position</b><br/>The system will move to the defined position on the turntable.</p> <p><b>Current position</b><br/>The system will start looking for the first beaker to come.</p> <p><b>Next beaker</b><br/>The system will move to the beaker which is next to the tower (home position + 1). If no beaker can be detected, the sample changer moves to the next position (home position + 2) and repeats until a beaker is detected.</p> | "Automation" = "InMotion"<br>Only in method type "clean" |
| Formula (Condition) | Define a specific condition for method function "park".   | "Automation" = "InMotion"<br>"Condition" is activated    |

## 6.2 Products

By means of products, product-specific adjustments to methods can be made. Each product is respectively associated with one method. and several products can be association with the same method. The product parameters are a subset of the method parameters. Products are created and managed in the product editor.

When a method is saved, the products that access this method are updated.



## 6.2.1 Create Products

Select: Home > Methods / products > Products

You create a new product if you either select and configure defined products from the list and save them under a new ID or generate a completely new product. The following description shows how you can generate a new product:

- ▶ Open the method selection window via the button **New** in the **Products** dialog. Here all the methods of the type **Measurement** are listed that can be assigned to a product.
    - 1 Touch the corresponding method in the list that should be assigned to the product.
      - ⇒ The **Product** dialog is opened. The parameter "Linked method" shows the ID of the selected methods.  
**Note:** You can retrospectively assign another method to the product (same configuration).
    - 2 You can edit and configure product parameters, assign the product an ID and a title.
- You can start the product immediately or return to the product editor.

## 6.2.2 Linking Methods with Products

A distinction is made between two cases:

1. A product is created and linked with a method.

On linking of a product to a method (before saving the first time) the values are taken over from the linked method.
2. A product has been previously created, the linked method is changed (relinking).

In this case only the methods for the relinking are suggested that agree with the currently linked method in the configuration. After initial saving, the product parameters are not overwritten by the parameters of the method.

For the measurement the product parameters are: such as e.g. Multiple measurements, Calculations (Coefficients and result limits) are used and not the parameters of the corresponding method. The entries in the method however remain unchanged.



- When you start a product measurement, the parameters defined in the method are "overwritten" by the product parameters.
- A maximum of 100 products can be defined.
- If no measurement methods have been defined on the device, no product can be created.
- Product ID's can be used for barcode recognition.
- Several products can be linked to the same method.
- A product is always assigned to exactly one method.
- When a method is deleted, all linked products are also deleted.
- If a product is saved under a new ID, the values are retained in the product and are not overwritten by standard values from the method.

## 6.2.3 Parameters for Products

The following parameters can be defined:

| Parameters                    | Description   | Displayed if |
|-------------------------------|---|--------------|
| Product ID                    | The product is uniquely identified in the system via the product ID.  | -            |
| Product title                 | Name of the product   | -            |
| Linked method                 | Selection of methods used in the product. With a new link, only methods with the same configuration (cell mode and external instruments) are shown. | -            |
| Cell mode                     | Display of cells to be used in the method (info field)  | -            |
| External instruments          | Display of external instruments (pH, conductivity, color) to be used in the method is to be measured (info field)                                   | -            |
| Color settings (Minolta only) | Activates "Illuminant" so that the illuminant type can be defined and "Observer" so that the angle can be entered.                                  | -            |

|                      |  |  |
|----------------------|--|--|
| Illuminant           | The following illuminants can be selected:<br>A, C, D65, D50, ID65, ID50, F2 to F12  | "Color settings" (Minolta only)" activated   |
| Observer             | Viewing angle:<br>2°C or 10°C; default 2°C   | "Color settings" (Minolta only)" activated   |
| Speed                | <b>Pump speed</b><br>"SC1" / "SC30": <ul style="list-style-type: none"> <li>• "Maximum": Sample feed with maximum pump speed</li> <li>• "Reduced": Sample feed with speed set at the automation unit</li> <li>• "Automatic": The pump speed changes according to the defined time period from "Reduced" to "Maximum".</li> </ul> "FillPal" / "InMotion": <ul style="list-style-type: none"> <li>• "High"</li> <li>• "Medium"</li> <li>• "Low"</li> </ul> The corresponding pump speed can be set under Home > Setup > Hardware > Automation. | "Automation" =<br>"FillPal" / "SC1" /<br>"SC30" / "InMotion"   |
| Max. speed after [s] | The pump switches over to the maximum speed after this time  | "Automation" = "SC1" /<br>"SC30"<br><br>"Speed" = "Automatic"  |
| Multiple measurement | On activation several measurements are performed on the same sample  | -  |
| No. of measurements  | Input of number of measurements  | "Multiple measurement" activated   |
| Refill ratio         | Measurement for further movement of the sample between two measurements. The refill ratio is calculated using the duration of the sample addition. For example: The addition duration is 10 s and the refill ratio is 50%, i.e. pumping continues for 5 seconds.   | "Automation" =<br>"FillPal" / "SC1" /<br>"SC30" / "InMotion"<br><br>"Repeat if failed" activated<br><br>"Multiple measurement" activated |
| Max. SD              | Maximum permitted absolute standard deviation of the measurements for density, refractive index or color. When the deviation is exceeded the measurement is interrupted with the status "Error".<br><br>The maximum standard deviation must be entered in the function of the measuring cell type. The default value in the method is provided for an R40 cell. This should be adjusted for an R50 cell, e.g. 0.00002.   | Multiple measurement activated   |
| No. of meas. points  | Defines the number of measured points used for determining the mean value.<br><b>Note:</b> If multiple measurement is activated, only the measured values from the last measurement repetition are used.   | pH or conductivity meter defined in method   |
| Max. deviation       | The max. permissible absolute deviation of the measured values for the pH or conductivity meter. If this value is exceeded, the measurement is interrupted with an "Error".  | pH or conductivity meter defined in method   |
| Repeat if failed     | If this is activated, the measurement is repeated if "Max. SD" or "Max. Deviation" are exceeded.<br><b>Note:</b> If "Multiple measurement" is activated, all measurements are repeated.  | "Multiple measurement" activated, or<br>External instrument defined (pH meter, conductivity meter, colorimeter)                          |
| Author               | Name of creator (info field)   | -  |
| Created on           | Date of creation and time (info field)   | -  |
| Modified at          | Change date and time (info field)  | -  |
| Modified by          | User who made change (info field)  | -  |

|         |  |   |
|---------|--|---|
| Protect | When this is activated, only the author or an administrator can edit or delete the method. | - |
|---------|--|---|

For the density module the following parameters are available:

|                      |   |   |
|----------------------|---|---|
| Bubble Check         | When this is activated, the system checks whether any bubbles are present in the cell.  | -   |
| Viscosity correction | Activation of the viscosity correction  | Density - Module defined  |
| Viscosity            | <p>≤2000:<br/>For samples with viscosity less than 2000 mPa*s</p> <p>&gt;2000:<br/>For samples with viscosity greater than 2000 mPa*s</p> <p>- Set value:<br/>With this selection, a known viscosity can be entered</p> | <p>Density - Module connected</p> <p>Viscosity correction activated</p> |
| Viscosity Value      | Viscosity of the sample   | "Viscosity" = "Set value"   |

## 6.2.4 Calculations in Products

The calculations defined in the method (Rx) are listed in the product. Press the button **Calculations** in the product dialog (Navigation: Home > Methods / products > Products). For a description of the parameters also see "Methods and products: Methods > Method functions > Calculation (page 47)".

The following rules apply for calculations in products:

1. When the methods are saved calculations in methods and products are compared on the basis of calculation indexes (R1 – R1, R2 – R2 etc.). If these indices from product and linked method do not coincide, they will be automatically aligned, i.e. product calculations that do not occur in the method will be automatically deleted and method calculations that do not occur in the product will be automatically inserted.
2. If a parameter is changed in the method function "Calculation" that is only visible in the product (non-editable, e.g. formula), then the entire product calculation will be overwritten in the associated product.

## 7 Series

Series act as a starting aid for several tasks. The tasks are individually lined up in the task list after the series start.

Series can be created, edited saved and deleted.

- You can create shortcuts for series.
- A maximum of 5 series can be saved.
- The maximum number of series entries is 60.
- Series can consist of products and / or methods.
- Series can consist of the same or different entries (i.e. several entries (from the type method or product). All entries can be deleted.
- Series can also be saved without entries.
- If you are in the **Start analysis** dialog of the series, series entries can be deleted, inserted or selected. Via the **Insert** button, you open the **Series item** dialog to define parameters; see also "Create series". If a change of series is made in the **Start analysis** dialog and a shortcut is created, this shortcut does not point to the changed series but to the series created in the series editor.
- If no methods are defined in the instrument, no new series can be created.

### Create series

**Navigation:** Home > Series

- ▶ Via the button **Series** in the Homescreen you open the **Series list** dialog. The available series are displayed.
  - 1 Touch the button **New**.
    - ⇒ A new series is generated. You can enter a series ID or use the default ID.
  - 2 Save the series.
    - ⇒ A dialog with the title of the newly created series opens. You can add new entries or edit existing ones. To edit an existing entry, touch the relevant entry. The **Series item** dialog opens.
  - 3 For a new series entry, press the button **Insert** in the dialog of the selected series.
    - ⇒ The **Series item** dialog is opened.
  - 4 Enter the parameters and confirm with **OK**.
    - ⇒ In the case of multiple entries, "Insert" markers appear behind the series entries.
  - 5 Press the **Insert** marking area at the desired point.
    - ⇒ The **Series item** dialog is opened.
  - 6 Enter the parameters and confirm with **OK**.
  - 7 Save the series.

The parameters for the **Series item** dialog are listed below:

| Parameters        | Description  | Displayed if                  |
|-------------------|--|-------------------------------|
| Item type         | The series item can either be a product or a method (only if at least one product is defined in the system).   | -                             |
| Product ID        | Selection of product   | "Item type" = "Product"       |
| Method ID         | For "Item type"="Method", it is possible to select the relevant method here.<br>For "Item type"="Product", the associated method is displayed here (Info Field). | -                             |
| Method type       | Displays the type of method, e.g. measurement  | -                             |
| Sample ID         | Input of the sample ID   | "Method type" = "Measurement" |
| Number of entries | To define the quantity of series entries.  | -                             |

For the entry type "Method" of the type "Adjustment" and "Test", you can change the associated standard data using the parameter "Standard". For this, see also "Methods and products: Methods > Standard data (page 40)".

|          |   |  |
|----------|---|--|
| Standard | For "Method type"="Adjustment", it is possible to modify the standard data.<br>For "Method type"="Test", the standard used is displayed (Info Field). | "Method type" = "Adjustment"<br>"Method type" = "Test" |
|----------|---|--|

A series can also be saved without entries.  
All entries can be deleted.

In the dialog of the corresponding series the **Start** button is found with which you can open the **Start analysis** dialog. In this you have the option to change your items again before the actual analysis start. To do this press the button **Items**.

In addition to the parameters described above, the following parameters are displayed:

|                   |   |                               |
|-------------------|---|-------------------------------|
| Correction factor | Any correction factor that can be used in calculations. | "Method type" = "Measurement" |
|-------------------|---|-------------------------------|

For more information on the parameters in the **Start analysis** dialog, see also "Analysis sequence: Starting an analysis (page 68)".

## 7.1 Delete Series

- 1 Touch the series to be deleted in the **Series list** dialog.
    - ⇒ A list with the corresponding items for the series appears.
  - 2 In the dialog press the **Parameters** button.
    - ⇒ In the dialog there is a **Delete** button with which you can delete the series.
-  A prompt with the interruption criterion appears before you finally delete the series.

## 7.2 Creating a series copy

Using the **Parameters** button, you can then copy an existing series by changing the "Series ID". When the series is saved a new series is created.

## 8 Results and Statistics

**Navigation:** Home > Results

You can get directly from the Homescreen to your analysis data via the **Results** button. Here the most recent 60 analyses with analysis status, analysis data, raw data, user-defined results, information on the analysis and statistical data are stored.

The performed analyses are listed, with the exception of manual operations and methods of the type "Clean".

The analysis list contains the following information:

- with methods of the method type and with products "P"
- Methods or product ID
- Sample ID (or Adjusting/Test mode for the method types "Adjustment" and "Test")
- Status, Result (Rx), Sample and Date/Time: Using the buttons **Status**, **Rx**, **Sample** and **Date/Time**, you can change between the various display modes.

The **Status** and **Rx** buttons enable you to change between the analysis status and the result of the first calculation of the method (for the method type "Measurement").<sup>2</sup>

The **Date/Time** and **Sample** buttons enable you to change between the date and time of the analysis and the sample ID. If **Sample** is selected, "Sample ID" appears (for the method type "Measurement"), "Air&Water" (for the method type "Adjustment") and, in the case of methods that use the SC30 sample changer, the sample rack position is displayed.

Executed analyses can have the following statuses:

- **OK**
- **OK\***  
Corresponds to the status "OK" with one of the following restrictions:
  - One adjusting or test set has expired.
  - An error has occurred after the method function "Measurement".
- **Error**  
Before the end of the method function "Measurement" an error has occurred.
- **Failed** (Methods of the type adjustment and Test):
  - "Adjustment": Adjustment analysis failed.
  - "Test": Tolerance exceeded.
- **Lim. exceeded** (Measurement type methods):  
The limits defined in the method function "Calculation" have been exceeded (for method type "Measurement").
- **Excluded:**  
The analysis has been manually excluded.

Analysis with the statuses "Error", "Failed" or "Lim. exceeded" are tagged in red.

- Via the button **Export** analyses of the type "Measurement" can be exported.
- By touching **Delete all** you can delete the analyses with all data.

To view the data of the performed analyses, proceed as follows.

- Touch the relevant analysis.
  - ⇒ For the selected analysis a new dialog opens. This dialog window contains the following buttons:
    - Calculated Results (only for the method type "Measurement")
    - Statistics (only for the method types "Measurement" and "Statistics")
    - Information
    - Data
    - Back
    - Report
    - Exclude

By touching the button **Exclude** individual analyses can be excluded from the statistics.

You can print or export a report manually by touching the **Report** button. The data included are the data used in the method. (See also the "Report (page 50)" method function ("Methods and products: Methods>Methods>Method functions").

### See also

- Calculation (page 47)
- Results and Statistics (page 62)

## 8.1 Statistics

Via the button **Statistics** you can also display the statistics (the statistics are listed per calculation, if in the method function "Calculation" the parameter "Statistics" has been activated). As a component of the statistics (Rolling statistics) the following values are displayed:

- Mean value  $\bar{x}$  of a result Rx (Mean [Rx])
- The standard deviation of a result Rx (SD)

The following criteria apply for the interruption of the rolling statistics:

1. Change of method ID or product ID.  
The automatic sample ID extension which is added to the ID when working in continuous run (XY\_\_1, XY\_\_2) is ignored for the statistic. That means only the user edited ID XY is taken as sample ID.
2. In the setup (Navigation: Home > Setup > Global settings > Analysis and resources behavior), you can activate the setting "Reset statistics with other sample ID". In this case the statistics are also reset if the sample ID changes.

The rolling statistics are not interrupted in measurements with the status "Error" and "Excluded". The measurements are not however taken into account in the rolling statistics. On the other hand, analyses with the status "OK\*" or "Lim. exceeded" are included in the statistics (the description of the analysis is found at the start of this section "Results and Statistics (page 62)").

## 8.2 Information

You received detailed information for the selected analysis result, e.g.:

- Automation unit
- Status
- Cell
- Method ID
- Sample ID
- Date / Time
- Performed by

## 8.3 Data

The raw data generated in the analysis is shown below Data, e.g.:

- Set temperature (standard) and the cell temperature
- nD
- nD1... nD10 (single values from multiple measurements)
- Meas. duration

### External instruments

#### - pH meter

- pH
- Max. Deviation
- Deviation
- Temperature

#### - Conductivity meter

- Conductivity
- Max. Deviation

- Deviation
- Temperature
- **Colorimeter**
  - Illuminant
  - Observer
  - For multiple measurements:
    - maxSDCOL
    - SDCol
  - Path length



## 9 Manual Operation

With the help of the manual operations, you may call up various functions of the instrument that are independent of the immediate execution of an analysis but which for example, may be helpful during the preparation of the samples.

- **Cell**

Via the manual operation "Cell" a cell conditioning run can be started. If you have connected the density - module, you can also start a cell test.

### 9.1 Automation

**Navigation:** Home > Manual operations > Automation

You can perform the following manual operations with the automation units:

| Action           | DryPal | FillPal | SC1 | SC30 | InMotion |
|------------------|--------|---------|-----|------|----------|
| Dry              | X      |         | X   | X    |          |
| Rinse            |        | X       | X   | X    | X        |
| Drain            |        |         |     |      | X        |
| Pump sample      |        | X       | X   | X    | X        |
| PowerShower      |        |         |     |      | X        |
| Stir             |        |         |     |      | X        |
| Move to position |        |         |     | X    | X        |
| Move lifft       |        |         |     |      | X        |

If no automation is defined in the setup, the manual operation "Automation" does not appear.

- Open the **Automation** dialog window via the button **Automation** in **Manual operations**.

In it you can define the following parameters to perform a manual operation with an automation unit:

| Parameters | Description  | Displayed if |
|------------|--|--------------|
| Cell mode  | Defines the cell(s)  | -            |
| Automation | Definition of the automation unit for manual operation   | -            |
| Action     | Specifies the action with which the manual operation is to be performed. The offered selection depends on the automation selected. | -            |

Below the parameters are listed that are to be entered for the selected action:

#### 9.1.1 Action: Dry

| Parameters        | Description  | Displayed if                                     |
|-------------------|--|--|
| Dry mode          | Fixed duration:<br>Drying is stopped after a defined time<br>For the density - the "dry mode" can also be set to "Automatic":<br>Automatic:<br>Drying is interrupted, when the oscillation value becomes stable. | Drying activated                                 |
| Dry duration      | Drying time in [s]   | "Dry mode" = "Fixed duration"                    |
| Max. dry duration | Maximum drying time:<br>If the oscillation value has not stabilized by the end of this period, drying is terminated.   | Density - Module defined<br>Dry mode = Automatic |

#### 9.1.2 Action: Rinse

| Parameters     | Description  | Displayed if            |
|----------------|--|-------------------------|
| Solvent        | Definition of the solvent at the connections "Rinse 1" and "Rinse 2" | "Type" = "SC1" / "SC30" |
| Rinse duration | Duration of the rinse; Input from infinity "∞" is possible.          | -                       |

|                |  |                     |
|----------------|--|---------------------|
| Rinse position | <p><b>Absolute position</b><br/>The system will move to the defined position on the turntable for the start of a sample.</p> <p><b>Current position</b><br/>The system will start looking for the first beaker to come.</p> <p><b>Next beaker</b><br/>The system will move to the beaker which is next to the tower (home position + 1). If no beaker can be detected, the sample changer moves to the next position (home position + 2) and repeats until a beaker is detected.</p> | "Type" = "InMotion" |
|----------------|--|---------------------|

### 9.1.3 Action: Pump sample

| Parameters | Description  | Displayed if   |
|------------|--|--|
| Direction  | <p>Cell:<br/>Pump in direction cell</p> <p>Vial:<br/>Pump in direction vial</p> <p><b>Note:</b><br/>FillPal only pumps in one direction.<br/>The automation units SC1 /SC30 can pump in both directions.</p>   | -  |
| Speed      | <p>Pump speed<br/>"SC1" / "SC30":</p> <ul style="list-style-type: none"> <li>• "Maximum": Filling with maximum pump speed</li> <li>• "Reduced": Filling with speed set at the automation unit</li> </ul> <p>"FillPal" / "InMotion":</p> <ul style="list-style-type: none"> <li>• "High"</li> <li>• "Medium"</li> <li>• "Low"</li> </ul> <p>The appropriate pump speed can be set in Home &gt; Setup &gt; Hardware &gt; Automation.</p> | Automation = "FillPal" / "SC1" / "SC30" / "InMotion" |
| Duration   | Duration of pumping input from infinity is possible.   | -  |

### 9.1.4 Action: Move to position

| Parameters | Description  | Displayed if                  |
|------------|--|-------------------------------|
| Go to      | <p><b>Home:</b><br/>Sample changer (SC30 / InMotion) moves to position "Home"</p> <p><b>Relative position:</b><br/>Sample changer (SC30 / InMotion) moves a definable number of steps</p> <p><b>Absolute position:</b><br/>Sample changer (SC30 / InMotion) moves to an indefinite position</p> <p><b>Next vial / beaker:</b><br/>Sample changer (SC30 / InMotion) moves to next vial / beaker</p> | Type = "SC30" / "InMotion"    |
| Position   | Absolute position, that is approached by the sample changer.   | "Go to" = "Absolute position" |
| Direction  | Definition of the moving direction of the sample rack.   | Type = "SC30" / "InMotion"    |

## 9.2 Cell

**Navigation:** Home > Manual operations > Cell

Here you can perform cell conditioning.

## 9.2.1 Action: Cell conditioning

By means of **Cell conditioning** (standard setting) you can assign the cell a certain temperature, so that the cell is already at operating temperature before measurement takes place (e.g. evening before). The set temperature and the adjustment set are read out from the selected method and sent to the cell.

In the corresponding method the set temperature and the adjustment set have already been specified for the conditioning of the measuring cell(s).

You can define the corresponding parameters for the following actions:

| Parameters | Description   | Displayed if       |
|------------|---|--------------------|
| Type       | Method or product (at least one product must be defined)      | -                  |
| Method     | Method, with which the cell conditioning is to be performed.  | "Type" = "Method"  |
| Product    | Product, with which the cell conditioning is to be performed. | "Type" = "Product" |



Methods of the type "CLEAN" are not available here for selection.

## 9.2.2 Cell Test

If you are using a density - module, you can perform a cell test for it.

The **Cell test** is designed to check whether the cell is dry and clean. With this test a measurement is carried out with the air. The measured density of the air is compared with the theoretical value.

If the difference of the measured results is within the specified tolerance, the cell test counts as having been passed.

| Parameters         | Description  | Displayed if       |
|--------------------|--|--------------------|
| Max. test duration | Maximum duration of the cell test in [s]. If the measured value has not stabilized by this time, the cell test will be interrupted and counts as having been failed. | Action = cell test |
| Tolerance          | Permitted tolerance for passing the cell test  | Action = cell test |

## 10 Analysis Sequence

### 10.1 Starting an Analysis

An analysis can be started in various ways:

- **Start** from the editor (Methods/Products/Series)
- **Start** from Homescreen
- **Start** via shortcuts
- **Start** with barcode reader
- **Start** with ErgoSens

Depending on the settings and the way in which the program is called up, you can enter or check analysis-related data in the **Start analysis** dialog. The following parameters may be displayed:

| Parameters        | Description  | Displayed if   |
|-------------------|--|--|
| Method ID         | The method is uniquely identified in the system via the method ID. Once the method has been saved, the method ID can no longer be changed. A change of the method ID results in the creation of a copy of the method.  | -  |
| Method type       | Displays the type of method, e.g. measurement  | -  |
| No. of samples    | Enables you to enter the sample quantity (max. 120).   | "Method type" = "Measurement"  |
| Sample ID         | Sample ID can be entered; you can still change this ID at the analysis start.  | "Method type" = "Measurement"  |
| Start position    | You can define different start positions.<br><b>Home</b><br>Position number 1 on the turntable. The changer will move to position 1 for the start of a sample.<br><b>Absolute position</b><br>The system will move to the defined position on the turntable for the start of a sample.<br><b>Current position</b><br>The system will start looking for the first beaker to come.<br><b>Next beaker</b> (only InMotion)<br>The system will move to the beaker which is next to the tower (home position + 1). If no beaker can be detected, the sample changer moves to the next position (home position + 2) and repeats until a beaker is detected. | "Method type" = "Adjustment" / "Measurement" / "Test" / "Clean"(only InMotion) |
| Continuous run    | If "Continuous run" is activated, the same measurement will be started automatically at the end of a measurement.<br><ul style="list-style-type: none"> <li>• Continuous run remains in effect until it is terminated by means of the <b>Stop</b> button.</li> <li>• The sample vials are processed successively until an empty space is found on the sample changer.</li> </ul>   | "Method type" = "Measurement"  |
| Interval          | Defines the period in [min] between two successive analyses. The next analysis does not begin until the interval duration has elapsed.   | "Continuous run" activated   |
| Correction factor | Any correction factor that can be used in calculations.  | "Method type" = "Measurement"  |
| Comment           | A comment was entered before performance of the analysis in the <b>Start analysis</b> dialog.<br><br>Method type "Adjustment" / "Test" = The standards will be shown additionally.   | -  |

For **Series**, the following parameters can be modified in the **Series item** dialog.

- 1 To do this, select a defined series (in the **Series list** dialog) (see: "Series (page 60)").

- ⇒ The corresponding dialog box containing the defined series items appears.
- 2 Touch **Start**.
  - ⇒ The **Start analysis** dialog box appears.
- 3 Touch the button "Entries"
  - ⇒ The Series item dialog of the selected series opens.
- 4 If you touch an entry of the type "Method" or "Product" or touch the button **Insert**, the following parameters will be available:

| Parameters        | Description  | Displayed if                  |
|-------------------|--|-------------------------------|
| Item type         | The series item can either be a product or a method (only if at least one product is defined in the system).   | -                             |
| Product ID        | Selection of product   | "Item type" = "Product"       |
| Method ID         | For "Item type"="Method", it is possible to select the relevant method here.<br>For "Item type"="Product", the associated method is displayed here (Info Field). | -                             |
| Method type       | Displays the type of method, e.g. measurement  | -                             |
| Sample ID         | Input of the sample ID   | "Method type" = "Measurement" |
| Correction factor | Any correction factor that can be used in calculations.  | "Method type" = "Measurement" |
| Number of entries | To define the quantity of series entries.  | -                             |

For a "Method" of the type "Adjustment" and "Test", you can modify the associated standard data using the "Standard" parameter, see also "Methods and products: Methods > Standard data (page 40)".

|          |   |  |
|----------|---|--|
| Standard | For "Method type"="Adjustment", it is possible to modify the standard data.<br>For "Method type"="Test", the standard used is displayed (Info Field). | "Method type" = "Adjustment"<br>"Method type" = "Test" |
|----------|---|--|

## 10.2 Start from Editor (Methods/Products/Series)

If a method, a product or a series is selected, then these can be started via **Start**. Start from the editor always proceeds via the **Start analysis** dialog.

## 10.3 Start from Homescreen

In the Homescreen the **Start** button is also found that leads you directly to the **Start analysis** dialog. In it the method, product or series is listed that you most recently started. By touching **Start** again the analysis is immediately started.

## 10.4 Start via Shortcuts

You can create shortcuts for methods/products/series and manual operations that enable an immediate analysis start. You can create a shortcut in the **Start analysis** dialog via the button **AddToHome**. In the process you can define the position on the Homescreen and the title of the shortcut. You can also continue to define whether after touching the shortcut you are directed via the **Start analysis** dialog or whether the analysis is to be started immediately. After it is created, the shortcut will appear on the selected position on the home screen and can be selected there by touching it.

## 10.5 Start with Barcode Reader

The following two barcode reader types can be connected to the device:

- Handheld readers
- Built-in reader,  
this can be integrated in the sample changer (SC30 or InMotion).

Under `Home > Setup > Hardware > Peripherals > Barcode readers` you can configure the barcode readers. Here the information contained in the barcode and the format can be specified. If the barcode contains the sample, method or product ID you can also activate the parameter "Immediate start". When you are in the **Start analysis** dialog and scan in the barcode of a sample with a new sample ID, the barcode is transferred to the parameter "Sample ID". The task starts immediately. The most recently completed method starts with the new sample ID.



- The specified data from standards can be scanned in for adjustments and tests. To do this, start an adjusting and test method. In the **Start analysis** dialog touch the **Default**, whereupon the **Default Data** dialog opens. This displays the standard data that you scanned in with the barcode.
- Test methods can be started via barcode.

### 10.5.1 Start with Handheld Reader

If you are in the Homescreen, the online screen or in the task list, you can start an analysis by scanning in a barcode. Depending on the information in the **Barcode reader parameters** dialog (`Home > Setup > Hardware > Peripherals > Barcode readers`), a distinction is made between the following scenarios:

1. Parameter "Barcode information" = "Sample ID":  
After the barcode has been scanned, the **Start analysis** dialog is displayed. Here you can select the method / the product, with which the analysis is to be performed. By pressing **Start** the analysis is started.
2. Parameter "Barcode information" = "Sample ID/Method ID" or "Sample ID/Product ID":  
After the barcode has been scanned, the **Start analysis** dialog is displayed. By pressing **Start** the analysis is started.
3. Parameter "Barcode information" = "Method ID" or "Product ID":  
After the barcode has been scanned, the **Start analysis** dialog is displayed. Here you can enter the sample ID.



If "Immediate start" is activated in the setup of the barcode reader, then the analysis is immediately started, i.e. without the **Start analysis** dialog being displayed. The sample ID defined in the method is adopted.

### 10.5.2 Start with Built-in Barcode Reader

If a built-in barcode reader is connected, the button **BC Start** appears in the Homescreen (this button is only activated, if no task is lined up). By pressing this button the **Start analysis** dialog is displayed. Depending on the information in the **Barcode reader parameters** dialog (`Home > Setup > Hardware > Peripherals > Barcode readers`), a distinction is made between the following scenarios:

1. Parameter "Barcode information" = "Sample ID":  
In the **Start analysis** dialog you can select the method / product, with which the analysis is to be performed (all analyses are performed with the same method / product). After **Start** is pressed, the barcode of the first sample vial is scanned in and the first analysis started. The vials are sequentially processed until an empty item appears on the sample changer (SC30 or InMotion).
2. Parameter "Barcode information" = "Sample ID/Method ID" or "Sample ID/Product ID":  
After **Start** is pressed, the barcode of the first sample vial is scanned in and the first analysis started. The vials are sequentially processed according to the method/product information on the barcode. If there is an empty position on the sample changer (SC30 or InMotion), the analysis sequence is terminated.
3. Parameter "Barcode information" = "Method ID" or "Product ID":  
After **Start** is pressed, the barcode of the first sample vial is scanned in and the first analysis started. The vials are sequentially processed according to the method/product information on the barcode. The sample ID is taken over from the method or from the **Start analysis** dialog. If there is an empty position on the sample changer (SC30 or InMotion), the analysis sequence is terminated.  
By touching **Stop** or **Reset** you can cancel the analysis sequence at any stage.

### 10.5.3 Start with ErgoSens

The ErgoSens is a movement sensor. A hand movement in front of the sensor immediately starts the method, product or series most recently used by you.

If you have activated the parameter "Confirm end of the analysis", at the end of the analysis a confirmation via the ErgoSens takes place; instead of confirmation by **OK**.

An analysis start by barcode with the ErgoSens can be initiated with the button **Barcode start** (for SC30) (if the last start was initiated with this button).

## 10.6 Continuous run

At the start of a measuring method or product by the editor, homescreen or a shortcut, you can select "Continuous run". At the end of an analysis, the same analysis will start again automatically after the defined wait time (interval).

If a sample changer (SC30 or InMotion) is used, the sample vials are processed successively until an empty space is found on the sample changer. The sample ID receives the suffix "\_\_01" and is incremented.



An analysis with the "Continuous run" parameter activated is terminated in the following ways:

- via **Stop** button,
- in the event of a fatal error,
- if no more sample vials are available (SC30 or InMotion).

## 10.7 Analysis Termination

Ongoing analyses can be canceled in the online screen via the button **Stop** or **Reset** (detailed information on the online screen can be found in "Tasks and online screen (page 73)").

The current analysis is stopped and the processing of the next task is interrupted. To continue the waiting tasks, open the task list (with the **Tasks** button) and press **Continue**.

## 10.8 Errors in the Analysis Sequences

Analyses can exhibit faults. Three types of faults can be identified during an analysis sequence:

- **Error** (e.g.: max. fill duration exceeded)
- **Error with termination** (e.g.: sample needle on the SC30 block)
- **Critical error** (e.g.: fan stopped)

### 10.8.1 Malfunction Types: Error

Malfunctions of the type **Error** are for example:

- Max. filling duration exceeded
- Max. meas. duration exceeded

The malfunction **Error** triggers the following behavior:

- A message appears with information and hints on the error.
- The task is continued to completion, however the method functions "Fill" and "Measure" are skipped.
- The processing of further tasks is interrupted.

Exception: With the SC30 or InMotion autosampler the tasks list is only interrupted, if the error occurs in one of the method functions "Clean" or "Cell test" (only for the density - module).

- The analysis with the status "Error" is listed in the analysis list under *Home > Results*.
- Not all errors on the pH or conductivity meter can be displayed on the refractometer.

### 10.8.2 Malfunction Types: Terminate error

Malfunctions of the type **Error with termination** are for example:

- Errors with respect to temperature adjustment
- **Sample needles** from sample changer (SC30 or InMotion) blocked.

The malfunction **Error with termination** triggers the following response:

- An information message on the relevant error appears.
- The task is terminated immediately.
- The processing of further tasks is interrupted. No further actions are executed, including cleaning or movement of the sample changer (SC30 or InMotion).

### 10.8.3 Malfunction Types: Critical error

Malfunctions of the type **Critical error** are for example (also see "Annex: Critical error"):

- Fan stopped
- Temperature sensor malfunction
- Temperature too high

The malfunction **Critical error** triggers the following response:

- A message appears with information on the error.
- The device switches off automatically after 20 seconds.



Critical errors can also occur when no task is running.



## 11 Tasks and Online Screen

If an analysis is started, the online screen is displayed.

If a task is already running and a new analysis is started, the task list with the waiting tasks is displayed.

### 11.1 Tasks

Tasks are processed in sequence. No tasks can be performed in parallel.

The task list shows tasks that are currently in the queue and tasks that are currently running.

The task list offers the following options:

- Display of online screen:  
By touching the list entry of the ongoing task, the online screen is displayed.
- Interrupt:  
By touching the button **Interrupt**, the processing of the tasks is interrupted. The ongoing task is then carried out to completion. By touching **Resume** you can continue the processing of the task.
- Remove all:  
This button is only visible, if the task list is interrupted and no more tasks are running. By touching this button all lined up tasks are removed.
- Move tasks:  
Touch a task. By changing the "number", you can move the task.
- Delete individual tasks:  
Touch a task. By touching the button **Remove** the task is deleted from the list.
- Editing the sample ID  
Entering a comment.

#### 11.1.1 "Tasks" Button

The **Tasks** button is located at the top right of the display. If it is activated, as soon as at least one task is lined up.

By touching the button **Tasks** you go to the online screen or the task list, if several tasks are lined up.

Status display of the button **Tasks**:

- Blue:  
No task is lined up.
- Yellow:  
A task is running right now.
- Yellow / blue blinking:  
A task has been finished and is waiting for confirmation
- Red:  
The task list is interrupted and no task is running.

### 11.2 Online Screen

The online screen displays the status and the readings of the ongoing analysis.

#### 11.2.1 Method type: Measurement

The info boxes at the top of the online screen show either the method or product ID, method or product title and the sample ID as well as the current analysis sequence step.

At the bottom of the screen the set and actual temperatures (Tset and Tcell) are displayed. The calculations (Rx) that are displayed can be defined using the method function "Online Display".

When you touch the button for individual calculations, the data relating to the calculation concerned are displayed. From here you can select another calculation (specified in the method) via the button **Select result** that is to be displayed during the runtime (each result Rx can only be displayed once).

In the online screen the button **Calculated results** is displayed that shows all calculations (Rx) for the method.

### **11.2.2 Method Type: Adjustment**

The info fields at the top of online screen show the method ID, the adjustment standards and the current analysis sequence step. At the bottom of the display the set and actual temperatures are shown. When the method is running the refractive index (incl. standard value) is displayed.

### **11.2.3 Method Type: Test**

The info fields at the top of online screen show the method ID, the test standards and the current analysis sequence step. At the bottom of the screen the set and actual temperatures are displayed. During the method the refractive index (incl. nominal value) and deviation from the nominal value (incl. tolerance) are displayed online.

### **11.2.4 Method Type: Clean**

The info fields at the top of online screen show the method ID and the current analysis sequence step. At the bottom of the screen the set and actual temperatures are displayed.

## 12 Appendix

### 12.1 Raw Data

#### Refractometer measuring cell

|             |   |
|-------------|---|
| nD          | Refractive index                        |
| nD1... nD10 | Single values from multiple measurement |

#### Common raw data

|   |   |
|---|---|
| Tset  | Set temperature   |
| Tcell   | Actual temperature at the time of measured value acquisition  |
| SD  | Standard deviation for multiple measurements.   |
| MaxSD   | Maximum permitted absolute standard deviation of measurements if multiple measurements are taken.   |
| p   | Atmospheric pressure  |
| f   | Correction factor   |
| R1...R20  | Results from "Calculation" method function  |
| TC1...TC5   | Results from "Temperature compensation" method function   |
| H[ ]  | Auxiliary values (global variables)   |
| AuxInst1[1] ... AuxInst1[x],<br>AuxInst2[1] ... AuxInst2[x] | The result of the "Auxiliary instrument" method function from the sequence of the external auxiliary instrument (see also Methods and products: Methods Method functions > Auxiliary instrument (page 53)). |
| RLim[1] ... RLim[x]   | The result describes whether the limit is within or outside of the result limits (0: within limits, 1: outside limits).   |
| MeasOK  | Result for the measurement status (0: "error" - measurement failed, 1: "OK").   |
| TIME  | Duration from the start of the method to the time of calculation of "TIME".   |
| DRY   | Result of the "Clean" method function for "Drying mode" = "Automatic" (0: "not passed", 1: "passed").   |
| TE  | Result of the test of the method of type "Test" (0: "not passed", 1: "passed").   |
| ADJAN   | Result of the test of the method of type "Test" (0: "not passed", 1: "passed")  |
| t   | Measurement duration (Method type "Measurement" or "Test").   |
| t1  | Measurement duration standard 1 (method type "Adjustment").   |
| t2  | Measurement duration standard 2 (method type "Adjustment").   |

#### Density - module

|               |  |
|---------------|--|
| OSC           | Oscillation: Actual measurement signal   |
| OSC1... OSC10 | Single oscillation from multiple measurements.   |
| d             | Density <ul style="list-style-type: none"> <li>• During the measurement, the extrapolated density is displayed as soon as it is received.</li> <li>• If viscosity correction is activated, the viscosity-corrected density is transferred at the end of the measurement.</li> </ul>                                  |
| d1...d10      | Single values from multiple measurements.  |
| dRaw          | Uncorrected density. Differences to d: <ul style="list-style-type: none"> <li>• During the measurement, the <b>non</b>-extrapolated density is displayed.</li> <li>• At the end of the measurement, the viscosity-corrected density is <b>not</b> transferred, even if viscosity correction is activated.</li> </ul> |
| dA            | Apparent density   |
| SG            | Specific weight: Density of the sample divided by the density of water at the measurement temperature.   |
| SGA           | Apparent specific weight   |

|       |   |
|-------|---|
| SG4   | Specific weight 4 °C: Density of the sample divided by the density of water at 4 °C.  |
| SG4A  | Apparent specific weight 4 °C   |
| SG4   | Specific weight 60 °F: Density of the sample divided by the density of water at 60 °F |
| SG60A | Apparent specific weight 60 °F  |
| F     | Adjustment factor   |
| CT    | Result of the "Cell test" method function (0: "not passed", 1: "passed").             |
| DevCT | Deviation of the cell test from the nominal value.                                    |

#### External instruments

|            |   |
|------------|---|
| pH         | pH value  |
| DevpH      | Maximum deviation in the pH measurement.  |
| MaxDevpH   | The maximum permitted absolute deviation of measured values for pH.   |
| TpH        | Temperature pH  |
| COND       | Conductivity  |
| DevCOND    | Maximum deviation in the conductivity measurement.  |
| MaxDevCOND | The maximum permitted absolute deviation of measured values for conductivity.                                       |
| TCOND      | Temperature conductivity  |
| SDCOL      | Standard deviation of the measured values for color in the case of multiple measurements.                           |
| MaxSDCOL   | Maximum permitted absolute standard deviation of the measured values for color, if multiple measurements are taken. |

## 12.2 Result proposals

#### List of the predefined results

|  |  |
|--|--|
| <b>Application d: Others</b>   |  |
| Twaddell number  | Based on the specific weight SG at meas. temperature.<br>$^{\circ}\text{Twad} = 200 * (\text{SG} - 1)$   |
| Baumé degree   | Based on the specific weight SG at meas. temperature.<br>For samples heavier than water:<br>H. °Be = $((1/\text{SG}) - 1) * -144.3$ , at 15°C<br>H. Bé (US) = $((1/\text{SG}) - 1) * -145$ , at 60°F<br>For samples lighter than water:<br>Lt. °Bé = $10 + 144.3 * ((1/\text{SG}) - 1)$ , at 15°C<br>Lt. °Bé (US) = $10 + 145 * ((1/\text{SG}) - 1)$ , at 60°F |
| <b>Application d: Alcohol</b>  |  |
| Jap. Sake deg.   | Sake Grade (Japan), based on the specific weight SG, measured at 15°C<br>$\text{Jap. Sake deg.} = ((1/\text{SG}) - 1) * 1443$  |
| Milk degrees   | Based on the specific weight SG at meas. temperature.<br>$\text{Milk deg.} = 1000 * (\text{SG} - 1)$   |
| Alc. (%v/v) OIML @20°C<br>Alc. (%v/v) OIML @60°F<br>Alc. (%v/v) OIML @15°C | % volume of ethanol at the stated temperature, as per the OIML R-22 (International Organization of Legal Metrology, Recommendation 22: alcohol tables), temperature scale IPTS 68, based on the absolute density (in vacuum)   |
| Alc. (%w/w) OIML   | % weight ethanol, as per the OIML R-22 (International Organization of Legal Metrology, Recommendation 22: alcohol tables), temperature scale IPTS 68, based on the absolute density (in vacuum)  |
| Alc. d @20°C<br>Alc. d @60°F<br>Alc. d @15°C                               | True density (in vacuo) of an ethanol sample at the stated temperature, as per OIML R-22   |

|  |   |
|--|---|
| Alc. dA @20°C<br>Alc. dA @60°F<br>Alc. dA @15°C  | Apparent density (in Air) of an ethanol sample at the stated temperature  |
| Alc. SGA @20°C<br>Alc. SGA @60°F<br>Alc. SGA @15°C   | Apparent relative density (in air), SG(t/t), of an ethanol sample at the stated temperature   |
| Alc. (Proof) USA   | US proof degree at 15.56°C (60°F), based on the true density  |
| Alc. (%v/v) HM C&E<br>Alc. (%w/w) HM C&E   | % volume ethanol as per H.M. C&E Table, at 20°C   |
| Alc. (%v/v) Canada @20°C   | % volume ethanol at 20°C, as per the Canadian ethanol tables  |
| Alc. (proof) UK  | UK proof degree at 15.56°C (60°F)   |
| Alc. (%v/v) OIML ITS90 @20°C<br>Alc. (%v/v) OIML ITS90 @60°F<br>Alc. (%v/v) OIML ITS90 @15°C | % volume of ethanol at the stated temperature, as per the OIML R-22 (International Organization of Legal Metrology, Recommendation 22: alcohol tables), new temperature scale ITS 90, based on the true density (in vacuum) |
| Alc. (%w/w) OIML ITS90   | % weight ethanol, as per the OIML R-22 (International Organization of Legal Metrology, Recommendation 22: alcohol tables), new temperature scale ITS 90, based on the true density (in vacuum)                              |
| Alc. (%v/v) AOAC   | % volume ethanol at 60°F, or % weight ethanol, as per AOAC tables (American Organization of Analytical Chemists), based at the true density at 20°C.  |
| Alc. (%v/v) Gay-Lussac   | %-volume ethanol at 15°C, as per OIML R-22 (International Organization of Legal Metrology, Recommendation 22: (alcohol tables), new temperature scale IPTS 68, based on the true density (in vacuum)                        |
| <b>Application d: Sugar</b>  |   |
| Plato d  | Extract-content in percentage weight (% w/w), Plato table, from true density at 20°C  |
| Brix d NBS 113   | Saccharose content in percentage weight (% w/w), NBS table 113, from true density at 20°C   |
| Brix d Emmerich  | Saccharose content in percentage weight (% w/w), according to A. Emmerich, Zuckerindustrie 119 (1994), from true density at 20°C  |
| HFCS42 d   | %-weight HFCS syrup (High Fructose Corn Syrup) with 42 % fructose fraction, based on true density at 20°C. Must be measured at 20°C.  |
| HFCS55 d   | %-weight HFCS syrup (High Fructose Corn Syrup) with 55 % fructose fraction, based on true density at 20°C. Must be measured at 20°C.  |
| Invert sugar d   | %-weight invert sugar, based on true density at 20°C. Must be measured at 20°C.   |
| KMW d  | Klosterneuburg sugar grade (Austria). Precise sugar content in grape juice. Based on true density at 20°C.  |
| Babo (KMW) d   | Sugar content in grape juice (Italy). Based on true density at 20°C.  |
| Oechsle d  | Oechsle degree in grape juice, based on the specific weight at 15°C. °Oe = (SG-1) * 1000, with d in g/cm <sup>3</sup>   |
| <b>Application nD: Others</b>  |   |
| Zeiss (14.45)  | Zeiss number, based on nD(20°C). Pure water gives a value of 14.45.   |
| Zeiss (15.0)   | Zeiss number, based on nD(20°C). Pure water gives a value of 15.0.  |
| <b>Application nD: Sugar</b>   |   |
| Brix nD @ Tx   | Saccharose content in % .weight as per ICUMSA, 20th session in Colorado Springs (1990). Also corresponds to OIML R 108 (1993). Result without temperature compensation to 20°C.   |
| Brix nD comp 20C   | Saccharose content in % .weight as per ICUMSA, 20th session in Colorado Springs, 1990. Also corresponds to OIML R 108 (1993). Result compensated to 20°C.   |
| Invert sugar nD  | % weight invert sugar, as per ICUMSA, 20th session in Colorado Springs (1990). Result without temperature compensation to 20°C.   |

|            |  |
|------------|--|
| HFCS 42 nD | % weight HFCS syrup (High Fructose Corn Syrup) with 42 % fructose fraction. Based on the refractive index at 20°C. Must be measured at 20°C. |
| HFCS 55 nD | % weight HFCS syrup (High Fructose Corn Syrup) with 55 % fructose fraction. Based on the refractive index at 20°C. Must be measured at 20°C. |
| Oechsle nD | Oechsle degree from grape juice, based on the refractive index at 20°C.  |

### 12.3 Refractive Index for Water

| Temp. [°C] | Refractive index (nD) | Temp. [°C] | Refractive index (nD) | Temp. [°C] | Refractive index (nD) | Temp. [°C] | Refractive index (nD) |
|------------|-----------------------|------------|-----------------------|------------|-----------------------|------------|-----------------------|
| 5          | 1.33388               | 25         | 1.33250               | 45         | 1.32985               | 65         | 1.32628               |
| 6          | 1.33385               | 26         | 1.33240               | 46         | 1.32969               | 66         | 1.32609               |
| 7          | 1.33382               | 27         | 1.33229               | 47         | 1.32953               | 67         | 1.32589               |
| 8          | 1.33378               | 28         | 1.33217               | 48         | 1.32937               | 68         | 1.32568               |
| 9          | 1.33373               | 29         | 1.33206               | 49         | 1.32920               | 69         | 1.32548               |
| 10         | 1.33369               | 30         | 1.33194               | 50         | 1.32904               | 70         | 1.32527               |
| 11         | 1.33363               | 31         | 1.33182               | 51         | 1.32887               | 71         | 1.32507               |
| 12         | 1.33358               | 32         | 1.33170               | 52         | 1.32870               | 72         | 1.32486               |
| 13         | 1.33352               | 33         | 1.33157               | 53         | 1.32852               | 73         | 1.32464               |
| 14         | 1.33345               | 34         | 1.33144               | 54         | 1.32835               | 74         | 1.32443               |
| 15         | 1.33338               | 35         | 1.33131               | 55         | 1.32817               | 75         | 1.32422               |
| 16         | 1.33331               | 36         | 1.33117               | 56         | 1.32799               |            |                       |
| 17         | 1.33324               | 37         | 1.33104               | 57         | 1.32781               |            |                       |
| 18         | 1.33316               | 38         | 1.33090               | 58         | 1.32762               |            |                       |
| 19         | 1.33307               | 39         | 1.33075               | 59         | 1.32744               |            |                       |
| 20         | 1.33299               | 40         | 1.33061               | 60         | 1.32725               |            |                       |
| 21         | 1.33290               | 41         | 1.33046               | 61         | 1.32706               |            |                       |
| 22         | 1.33280               | 42         | 1.33031               | 62         | 1.32687               |            |                       |
| 23         | 1.33271               | 43         | 1.33016               | 63         | 1.32668               |            |                       |
| 24         | 1.33261               | 44         | 1.33001               | 64         | 1.32648               |            |                       |

### 12.4 Density

#### Density of air

$$\rho = 0.0012930 / (1 + 0.00367 \cdot t) \cdot (p / 1013.25)$$

t = temperature in [°C]

p = absolute atmospheric pressure in [mbar] or [hPa]

| Temp. [°C] | Density [g/cm³] | Temp. [°C] | Density [g/cm³] |
|------------|-----------------|------------|-----------------|
| 0          | 0.00129         | 46         | 0.00111         |
| 1          | 0.00129         | 47         | 0.00110         |
| 2          | 0.00128         | 48         | 0.00110         |
| 3          | 0.00128         | 49         | 0.00110         |
| 4          | 0.00127         | 50         | 0.00109         |
| 5          | 0.00127         | 51         | 0.00109         |
| 6          | 0.00127         | 52         | 0.00109         |
| 7          | 0.00126         | 53         | 0.00108         |
| 8          | 0.00126         | 54         | 0.00108         |
| 9          | 0.00125         | 55         | 0.00108         |
| 10         | 0.00125         | 56         | 0.00107         |
| 11         | 0.00124         | 57         | 0.00107         |
| 12         | 0.00124         | 58         | 0.00107         |

| Temp. [°C] | Density [g/cm <sup>3</sup> ] | Temp. [°C] | Density [g/cm <sup>3</sup> ] |
|------------|------------------------------|------------|------------------------------|
| 13         | 0.00123                      | 59         | 0.00106                      |
| 14         | 0.00123                      | 60         | 0.00106                      |
| 15         | 0.00123                      | 61         | 0.00106                      |
| 16         | 0.00122                      | 62         | 0.00105                      |
| 17         | 0.00122                      | 63         | 0.00105                      |
| 18         | 0.00121                      | 64         | 0.00105                      |
| 19         | 0.00121                      | 65         | 0.00104                      |
| 20         | 0.00120                      | 66         | 0.00104                      |
| 21         | 0.00120                      | 67         | 0.00104                      |
| 22         | 0.00120                      | 68         | 0.00103                      |
| 23         | 0.00119                      | 69         | 0.00103                      |
| 24         | 0.00119                      | 70         | 0.00103                      |
| 25         | 0.00118                      | 71         | 0.00103                      |
| 26         | 0.00118                      | 72         | 0.00102                      |
| 27         | 0.00118                      | 73         | 0.00102                      |
| 28         | 0.00117                      | 74         | 0.00102                      |
| 29         | 0.00117                      | 75         | 0.00101                      |
| 30         | 0.00116                      | 76         | 0.00101                      |
| 31         | 0.00116                      | 77         | 0.00101                      |
| 32         | 0.00116                      | 78         | 0.00101                      |
| 33         | 0.00115                      | 79         | 0.00100                      |
| 34         | 0.00115                      | 80         | 0.00100                      |
| 35         | 0.00115                      | 81         | 0.00100                      |
| 36         | 0.00114                      | 82         | 0.00099                      |
| 37         | 0.00114                      | 83         | 0.00099                      |
| 38         | 0.00113                      | 84         | 0.00099                      |
| 39         | 0.00113                      | 85         | 0.00099                      |
| 40         | 0.00113                      | 86         | 0.00098                      |
| 41         | 0.00112                      | 87         | 0.00098                      |
| 42         | 0.00112                      | 88         | 0.00098                      |
| 43         | 0.00112                      | 89         | 0.00097                      |
| 44         | 0.00111                      | 90         | 0.00097                      |
| 45         | 0.00111                      |            |                              |

#### Density of water

- According to F. Spieweck, H. Bettin; Review: Solid and liquid density determination  
Part 1: tm – Technisches Messen 59 (1992) 6, p. 237 – 244  
Part 2: tm – Technisches Messen 59 (1992) 7/8, p. 285 – 292

| Temp. [°C] | Density [g/cm <sup>3</sup> ] | Temp. [°C] | Density [g/cm <sup>3</sup> ] |
|------------|------------------------------|------------|------------------------------|
| 0          | 0.99984                      | 46         | 0.98979                      |
| 1          | 0.99990                      | 47         | 0.98936                      |
| 2          | 0.99994                      | 48         | 0.98892                      |
| 3          | 0.99996                      | 49         | 0.98848                      |
| 4          | 0.99997                      | 50         | 0.98803                      |
| 5          | 0.99996                      | 51         | 0.98757                      |
| 6          | 0.99994                      | 52         | 0.98711                      |
| 7          | 0.99990                      | 53         | 0.98664                      |
| 8          | 0.99985                      | 54         | 0.98617                      |
| 9          | 0.99978                      | 55         | 0.98569                      |
| 10         | 0.99970                      | 56         | 0.98520                      |

| Temp. [°C] | Density [g/cm <sup>3</sup> ] | Temp. [°C] | Density [g/cm <sup>3</sup> ] |
|------------|------------------------------|------------|------------------------------|
| 11         | 0.99960                      | 57         | 0.98471                      |
| 12         | 0.99950                      | 58         | 0.98421                      |
| 13         | 0.99938                      | 59         | 0.98370                      |
| 14         | 0.99924                      | 60         | 0.98319                      |
| 15         | 0.99910                      | 61         | 0.98267                      |
| 16         | 0.99894                      | 62         | 0.98215                      |
| 17         | 0.99877                      | 63         | 0.98162                      |
| 18         | 0.99859                      | 64         | 0.98109                      |
| 19         | 0.99840                      | 65         | 0.98055                      |
| 20         | 0.99820                      | 66         | 0.98000                      |
| 21         | 0.99799                      | 67         | 0.97945                      |
| 22         | 0.99777                      | 68         | 0.97889                      |
| 23         | 0.99754                      | 69         | 0.97833                      |
| 24         | 0.99730                      | 70         | 0.97776                      |
| 25         | 0.99704                      | 71         | 0.97719                      |
| 26         | 0.99678                      | 72         | 0.97661                      |
| 27         | 0.99651                      | 73         | 0.97602                      |
| 28         | 0.99623                      | 74         | 0.97543                      |
| 29         | 0.99594                      | 75         | 0.97484                      |
| 30         | 0.99565                      | 76         | 0.97424                      |
| 31         | 0.99534                      | 77         | 0.97363                      |
| 32         | 0.99502                      | 78         | 0.97302                      |
| 33         | 0.99470                      | 79         | 0.97241                      |
| 34         | 0.99437                      | 80         | 0.97179                      |
| 35         | 0.99403                      | 81         | 0.97116                      |
| 36         | 0.99368                      | 82         | 0.97053                      |
| 37         | 0.99333                      | 83         | 0.96989                      |
| 38         | 0.99296                      | 84         | 0.96925                      |
| 39         | 0.99259                      | 85         | 0.96861                      |
| 40         | 0.99221                      | 86         | 0.96796                      |
| 41         | 0.99183                      | 87         | 0.96730                      |
| 42         | 0.99143                      | 88         | 0.96664                      |
| 43         | 0.99103                      | 89         | 0.96598                      |
| 44         | 0.99062                      | 90         | 0.96531                      |
| 45         | 0.99021                      |            |                              |

## 12.5 Critical errors

| Error code | Error   |
|------------|---|
| E007       | Fan 1 stopped                                 |
| E030       | Fan 2 stopped (only for the density - module) |
| E028       | Temperature sensor malfunction                |
| E029       | Thermomodule malfunction                      |
| E031       | Hardware error                                |
| E033       | Memory error                                  |
| E064       | Maximum temperature exceeded                  |
| E075       | Electric current too high                     |
| E076       | Voltage too high                              |



If a critical error occurs, a message is displayed. The instrument then switches off automatically after 20 seconds. If the problem is not resolved by a restart, please contact your authorized METTLER TOLEDO service agent.

# Index

## Numerics

|            |    |
|------------|----|
| 24V Output | 24 |
|------------|----|

## A

|                               |    |
|-------------------------------|----|
| Adjustment                    |    |
| Method function               | 52 |
| Method syntax                 | 39 |
| MF sample                     | 43 |
| Adjustment data               |    |
| Export                        | 35 |
| Adjustment parameters         |    |
| Setup, Cell                   | 17 |
| Adjustment sets               |    |
| Create                        | 16 |
| Delete                        | 16 |
| Analyses                      |    |
| Stopping                      | 71 |
| Analysis                      |    |
| Start                         | 68 |
| Analysis status               | 62 |
| AtmoSens                      |    |
| Verify availability           | 24 |
| Audio-Signal                  |    |
| Setting                       | 25 |
| Automation                    |    |
| Manual operation              | 65 |
| Automation units              |    |
| >Delete                       | 19 |
| Create                        | 18 |
| Types                         | 17 |
| Auxiliary Instrument          | 53 |
| Auxiliary Instruments         |    |
| 24V Output                    | 24 |
| USB-RS-232                    | 24 |
| Auxiliary values              |    |
| Create                        | 31 |
| Method function               | 52 |
| AuxInst                       | 75 |
| Variable auxiliary instrument | 54 |

## B

|                |    |
|----------------|----|
| Barcode reader |    |
| Start analysis | 70 |
| Beep           |    |
| Setting        | 25 |
| Bubble Check   | 46 |
| Buttons        |    |
| Info           | 12 |
| Reset          | 12 |

## C

|                              |    |
|------------------------------|----|
| Calculation, method function | 47 |
| Calculations in products     | 59 |
| Cell                         |    |
| Conditioning                 | 67 |
| Maintenance & Service        | 34 |
| Manual operation             | 66 |
| Cell parameters              | 17 |
| Cell test                    | 67 |

|                                 |    |
|---------------------------------|----|
| Cell test, method function      | 51 |
| Cell update                     | 34 |
| Cell, method function "Measure" |    |
| Method type "Adjustment"        | 45 |
| Method type "Measure"           | 45 |
| Method type "Test"              | 45 |
| Clean                           |    |
| Method syntax                   | 40 |
| Clean, method function          | 48 |
| Color scales                    | 20 |
| Formula editor                  | 40 |
| Condition, method function      | 40 |
| Conditioning                    |    |
| Cell                            | 67 |
| Configuration dialog            | 36 |
| Configuration, method function  | 42 |
| Configure barcode reader        | 21 |
| Configure USB stick             | 21 |
| Continuous run                  | 71 |
| Control type                    |    |
| Output 24 V                     | 53 |
| USB-RS-232                      | 53 |

## D

|                         |        |
|-------------------------|--------|
| Data                    |        |
| Analysis results        | 63     |
| Data storage            | 26     |
| Date and time           | 26, 26 |
| Define account policies | 27     |
| Density of air          |        |
| Temperature dependency  | 78     |
| Density of water        |        |
| Temperature dependency  | 79     |
| Drying                  | 49, 65 |

## E

|  |    |
|--|----|
| ErgoSens                                   |    |
| Activate                                   | 23 |
| Start analysis                             | 70 |
| Error                                      | 71 |
| Error detection, method function "Measure" |    |
| Method type "Adjustment / Test"            | 47 |
| Errors, critical                           | 80 |
| Expired Resources                          | 15 |
| Export                                     |    |
| Adjustment, test, measurement history      | 35 |
| External devices                           |    |
| Delete                                     | 19 |
| External instruments                       |    |
| Colorimeter                                | 20 |
| Conductivity meter                         | 19 |
| Create                                     | 19 |
| Edit                                       | 19 |
| Install                                    | 19 |
| pH meter                                   | 19 |
| Types                                      | 19 |
| Extinction                                 |    |
| Formula editor                             | 40 |

|                               |    |                              |    |
|-------------------------------|----|------------------------------|----|
| <b>F</b>                      |    | Functions                    | 31 |
| Filling, method function      | 44 | Import / Export of data      | 32 |
| Fingerprint reader            | 21 | MT Service                   | 32 |
| Firmware                      |    | Reset to factory settings    | 33 |
| List                          | 34 | update                       | 33 |
| Firmware history              | 33 | Malfunction                  |    |
| Formula editor                | 40 | Critical error               | 72 |
| Formula syntax                | 41 | Error with termination       | 71 |
| Formulas                      |    | Mathematical Functions and   | 41 |
| Example                       | 41 | Operators                    |    |
| in method functions           | 40 | Measure                      |    |
| Initials                      | 41 | Subfunction "Cell"           | 45 |
| <hr/>                         |    | Subfunction "Error detec-    | 47 |
| <b>G</b>                      |    | Subfunction "Measure-        | 46 |
| Global settings               |    | ment acquisition"            |    |
| Analysis and resources        | 28 | Measure, method function     | 45 |
| behavior                      |    | Measured value acquisition,  |    |
| Physical properties           | 29 | method function "Measure"    |    |
| System                        | 26 | Method types "Measure",      | 46 |
| Types                         | 26 | "Adjustment", "Test"         |    |
| User management               | 26 | Measurement                  |    |
| <hr/>                         |    | Method syntax                | 38 |
| <b>H</b>                      |    | Measurement history          |    |
| Handheld reader               |    | Export                       | 35 |
| Start analysis                | 70 | Memory copy                  | 32 |
| Hardware                      |    | Menu structure               | 15 |
| Auxiliary Instruments         | 24 | Method function              |    |
| List                          | 34 | Wait                         | 42 |
| History                       |    | Method functions             |    |
| Adjusting, test entries       | 17 | Adjustment                   | 52 |
| Homescreen                    |    | Aux. value                   | 52 |
| Buttons                       | 12 | Calculation                  | 47 |
| <hr/>                         |    | Cell test                    | 51 |
| <b>I</b>                      |    | Clean                        | 48 |
| Identification                |    | Condition                    | 40 |
| Define system settings        | 26 | Configuration                | 42 |
| Import/Export of data         | 32 | Filling                      | 44 |
| Information                   |    | Instruction                  | 52 |
| Analysis results              | 63 | Measure                      | 45 |
| Input fields                  |    | Online display               | 50 |
| Types                         | 13 | Report                       | 50 |
| Instruction, Method function  | 52 | Temperature compensa-        | 51 |
| Instrument update             | 33 | tion                         |    |
| Instruments                   |    | Test                         | 52 |
| Description                   | 8  | Title                        | 42 |
| <hr/>                         |    | Wait                         | 53 |
| <b>L</b>                      |    | Method Functions, Parameters |    |
| Language                      |    | Auxiliary Instrument         | 53 |
| Setting                       | 25 | Method quantity              | 36 |
| Layout of Terminal            | 12 | Method syntax                |    |
| LevelSens                     |    | Adjustment                   | 39 |
| Activate                      | 23 | Clean                        | 40 |
| Line rinse                    | 56 | Measurement                  | 38 |
| Linking of methods with prod- | 57 | Test                         | 39 |
| ucts                          |    | Method type                  |    |
| Lists                         |    | Adjustment                   | 43 |
| Sorting                       | 14 | Test                         | 43 |
| Lovibond                      | 20 | Method types                 | 36 |
| <hr/>                         |    | Methods                      |    |
| <b>M</b>                      |    | Create                       | 36 |
| Maintenance & Service         |    | Linking with products        | 57 |
| Firmware history              | 33 |                              |    |

|                                   |    |   |        |
|-----------------------------------|----|---|--------|
| Minolta                           | 20 | Activate                                  | 23     |
| MT Service, Maintenance & Service | 32 | Series                                    |        |
| <hr/>                             |    | Create, delete                            | 60     |
| <b>N</b>                          |    | Tasks                                     | 60     |
| Network – settings                | 23 | Setup-Menu                                | 15     |
| Network - storage                 | 23 | Shortcuts                                 |        |
| <hr/>                             |    | Create                                    | 26     |
| <b>O</b>                          |    | Homescreen                                | 14     |
| Online display, method function   | 50 | Sorting lists                             | 14     |
| Online Screen                     |    | Standard data                             | 40     |
| Adjustment                        | 74 | Standby display                           | 12     |
| Clean                             | 74 | Statistics                                |        |
| Measurement                       | 73 | Results                                   | 63     |
| Online screen and tasks           | 73 | Rolling statistics                        | 63     |
| Operation of the touchscreen      | 12 | Status                                    |        |
| Output 24 V                       | 53 | Analyses                                  | 62     |
| <hr/>                             |    | Stir                                      | 55     |
| <b>P</b>                          |    | Syntax, methods                           | 38     |
| Parameters                        |    | System settings                           |        |
| Products                          | 57 | Date and time                             | 26     |
| Park                              | 56 | Define                                    | 26     |
| PC – settings                     | 22 | <hr/>                                     |        |
| Peripherals                       |    | <b>T</b>                                  |        |
| Barcode reader                    | 21 | Tables                                    |        |
| Device types                      | 20 | Create                                    | 30     |
| Fingerprint reader                | 21 | Tasks and online screen                   | 73     |
| Network – settings                | 23 | Temperature compensation, method function | 51     |
| PC – settings                     | 22 | Test data                                 |        |
| Printer                           | 22 | Export                                    | 35     |
| USB data export                   | 22 | Test parameters                           |        |
| USB stick                         | 21 | Setup, Cell                               | 17     |
| PowerShower                       | 54 | Test sets                                 |        |
| Printer                           |    | Create                                    | 16     |
| Setup                             | 22 | Delete                                    | 16     |
| USB data export                   | 22 | Test, method function                     | 52     |
| Printing a PDF file               | 36 | Test, method syntax                       | 39     |
| Printing a report                 |    | Test, method type                         | 43     |
| Manually                          | 62 | Title, method function                    | 42     |
| Products                          |    | Touchscreen                               | 12     |
| Calculations                      | 59 | Transmission                              |        |
| Create                            | 57 | Formula editor                            | 40     |
| Linking with methods              | 57 | <hr/>                                     |        |
| Parameters                        | 57 | <b>U</b>                                  |        |
| Pump sample                       | 66 | Update, firmware                          | 33     |
| <hr/>                             |    | USB compact printer                       | 22     |
| <b>Q</b>                          |    | USB data export                           | 22     |
| Quantity of methods               | 36 | USB-RS-232                                | 24, 53 |
| <hr/>                             |    | USB-RS232 data export box                 | 22     |
| <b>R</b>                          |    | User – settings                           |        |
| Raw data                          | 75 | Shortcuts                                 | 26     |
| Report, method function           | 50 | User groups                               | 27     |
| Reset to factory settings         | 33 | User Interface                            |        |
| Results                           | 62 | Input Fields                              | 13     |
| Rights for users                  | 27 | User management                           |        |
| Rinse                             | 65 | Administer users                          | 27     |
| Rotate turntable                  | 66 | Define account policies                   | 27     |
| <hr/>                             |    | User rights                               | 27     |
| <b>S</b>                          |    | User settings                             |        |
| Sample, method function           | 42 | Audio-Signal                              | 25     |
| Screen                            |    | Beep                                      | 25     |
| Setting                           | 25 | Keyboards                                 | 26     |
| Sensors                           |    |   |        |

|          |    |
|----------|----|
| Language | 25 |
| Screen   | 25 |

---

**W**

|                       |    |
|-----------------------|----|
| Wait, method function | 53 |
| WasteSens             |    |
| Activate              | 23 |





## **To protect your product's future:**

METTLER TOLEDO Service assures the quality, measuring accuracy and preservation of value of this product for years to come.

Please request full details about our attractive terms of service.

[www.refractometry.com](http://www.refractometry.com)

For more information

**Mettler-Toledo AG, Analytical**

CH-8603 Schwerzenbach, Switzerland

Tel. +41 (0)44 806 77 11

Fax +41 (0)44 806 73 50

[www.mt.com](http://www.mt.com)

Subject to technical changes.

© Mettler-Toledo AG

51710794B

